

# USER MANUAL OFF-GRID INVERTER



## 6000XP

SCAN FOR UPDATED  
DOCUMENTS



## TABLE OF CONTENTS

1.	ABBREVIATIONS.....	1
2.	SAFETY .....	2
2.1	SAFETY INSTRUCTIONS.....	2
2.2	IMPORTANT SAFETY NOTIFICATIONS.....	2
3.	BRIEF INTRODUCTION.....	4
3.1	INVERTER FEATURES .....	4
3.2	INVERTER INTERFACE .....	5
3.3	STORAGE INFORMATION.....	6
4.	INSTALLATION.....	7
4.1	PACKING LIST .....	7
4.2	LOCATION SELECTION AND INSTALLATION .....	7
4.2.1	REQUIREMENTS FOR INSTALLATION LOCATION .....	7
4.2.2	INSTALLING THE INVERTER .....	8
4.2.3	MOUNTING STEPS .....	8
4.3	CONNECTION OVERVIEW .....	9
4.3.1	SYSTEM CONNECTIONS .....	9
4.4	PV CONNECTION .....	9
4.4.1	CONNECTING PV TO THE INVERTER .....	9
4.4.2	STRING SIZING .....	10
4.4.3	PV WIRING INSTRUCTIONS .....	11
4.5	BATTERY CONNECTION.....	12
4.5.1	BATTERY CABLE CONNECTION .....	12
4.5.2	LITHIUM BATTERY COMMUNICATIONS.....	13
4.6	AC WIRING INFORMATION .....	13
4.6.1	STEPS FOR AC CONNECTION .....	14
4.7	WORKING WITH A GENERATOR.....	14
4.7.1	GENERATOR SYSTEM CONNECTION.....	14
4.7.2	INTEGRATED DRY CONTACTS .....	15
4.7.3	GENERATOR AC CONNECTIONS .....	15
4.8	GENERATOR START AND STOP SETTINGS .....	16
4.9	OFF-GRID.....	16
4.9.1	OFF-GRID WIRING.....	16
4.10	PARALLELING INFORMATION .....	17
4.10.1	PARALLEL COMMUNICATION CONNECTIONS.....	17
4.10.2	PARALLEL CONFIGURATION.....	17
5.	END USER SETTINGS.....	18
5.1	APPLICATION SETTING.....	18
5.2	CHARGE SETTING.....	19
5.2.1	GENERATOR CHARGE.....	19
5.3	DISCHARGE SETTING.....	20
5.4	RESET .....	20
6.	INSTALLER SETTINGS .....	20
6.1	COMMON SETTING.....	20
6.2	APPLICATION SETTING.....	21
6.3	CHARGE SETTING.....	22
6.4	DISCHARGE SETTING.....	23

6.5	OTHER SETTING .....	24
6.6	RESET .....	24
7.	MONITOR SYSTEM SETUP .....	25
7.1	WI-FI/4G/LAN DONGLE CONNECTION .....	25
7.2	THIRD-PARTY RS485 COMMUNICATION.....	25
7.3	ONLINE MONITORING SYSTEM USER INTERFACE .....	26
7.3.1	DASHBOARD (MONITOR TAB) .....	26
7.3.2	DASHBOARD (DATA TAB) .....	29
7.3.3	DASHBOARD (CONFIGURATION TAB) .....	32
7.3.4	DASHBOARD (OVERVIEW TAB).....	33
7.3.5	DASHBOARD (MAINTENANCE TAB).....	34
8.	FIRMWARE UPDATES .....	35
8.1	FIRMWARE UPDATE VIA EG4 ELECTRONICS APP.....	35
8.2	FIRMWARE UPDATE VIA MONITOR CENTER (WEBSITE) .....	36
9.	SMARTPHONE APP SETUP .....	37
10.	OPERATION GUIDE .....	38
10.1	AC CHARGE MODE .....	38
10.2	RAPID SHUTDOWN (RSD).....	40
10.2.1	EXTERNAL RSD WIRING INSTRUCTIONS.....	40
10.3	LCD DISPLAY AND SETTINGS.....	41
10.3.1	LCD DISPLAY .....	42
11.	LCD SETTINGS .....	44
12.	INVERTER START-UP AND SHUT-DOWN PROCEDURE .....	53
12.1	START-UP.....	53
12.2	SHUT-DOWN .....	53
13.	ERROR/WARNING TABLES .....	54
13.1	ERROR DEFINITIONS AND TROUBLESHOOTING.....	54
13.2	WARNING DEFINITIONS AND TROUBLESHOOTING.....	55
14.	INVERTER MAINTENANCE.....	56
15.	TECHNICAL SPECIFICATIONS.....	56

## 1. ABBREVIATIONS

- AWG – American Wire Gauge
- A – Amp(s)
- Ah – Amp hour(s)
- AC – Alternating Current
- AHJ – Authority Having Jurisdiction
- ANSI – American National Standards Institute
- BMS – Battery Management System
- DC – Direct Current
- DIP – Dual In-line Package
- DOD – Depth of Discharge
- EG – Equipment Ground
- EGS – Equipment Grounding System
- EPS – Emergency Power System
- ESS – Energy Storage System
- E-Stop NO – Emergency Stop Normally Open
- GE – Grounding Electrode
- GEC – Grounding Electrode Conductor
- GES – Grounding Electrode System
- Imp – Maximum Power Point Current
- I<sub>sc</sub> – Short-Circuit Current
- In. lbs. – Inch Pounds
- kW – Kilowatt
- kWh – Kilowatt-hour
- LFP – Lithium Iron Phosphate or LiFePO<sub>4</sub>
- mm – Millimeter(s)
- mV – Millivolt(s)
- NEC – National Electrical Code
- NFPA – National Fire Prevention Association
- Nm – Newton Meters
- PC – Personal Computer
- PCB – Printed Circuit Board
- PE – Protective Earth (G or Ground)
- PPE – Personal Protective Equipment
- PV – Photovoltaic
- RSD – Rapid Shut Down
- SOC – State of Charge
- STC – Standard Testing Conditions
- V – Volt(s)
- VOC – Open-Circuit Voltage
- VMP – Voltage Maximum Power

## 2. SAFETY

### 2.1 SAFETY INSTRUCTIONS

International safety regulations have been strictly observed in the design and testing of the inverter. Before beginning any work, carefully read all safety instructions, and always observe them when working on or with the inverter. The installation must follow all applicable national or local standards and regulations.

**Incorrect installation may cause:**

- *injury or death to the installer, operator or third party*
- *damage to the inverter or other attached equipment*

### 2.2 IMPORTANT SAFETY NOTIFICATIONS



***DANGER: Hazardous Voltage Circuits!***

***AVERTISSEMENT: Circuits à tension élevée!***

There are various safety concerns that must be carefully observed before, during, and after the installation, as well as during future operation and maintenance. The following are important safety notifications for the installer and any end users of this product under normal operating conditions.

1. **Beware of high PV voltage.** Please install an external DC disconnect switch or breaker and ensure it is in the “off” or “open” position before installing or working on the inverter. Use a voltmeter to confirm there is no DC voltage present to avoid electric shock.
2. **Beware of high grid voltage.** Please ensure the AC switch and/or AC breaker are in the “off” or “open” position before installing or working on the inverter. Use a voltmeter to confirm there is no voltage present to avoid electric shock.
3. **Beware of high battery current.** Please ensure that the battery module breakers and/or on/off switches are in the “open” or “off” position before installing or working on the inverter. Use a voltmeter to confirm there is no DC voltage present to avoid electric shock.
4. **Do not open the inverter while it is operating** to avoid electric shock and damage from live voltage and current within the system.
5. **Do not make any connections or disconnections (PV, battery, grid, communication, etc.) while the inverter is operating.**
6. An installer should make sure to be well protected by reasonable and professional insulative equipment [e.g., personal protective equipment (PPE)].
7. Before installing, operating, or maintaining the system, it is important to inspect all existing wiring to ensure that it meets the appropriate specifications and conditions for use.
8. Ensure that the PV, battery, and grid connections to the inverter are secure and proper to prevent damage or injuries caused by improper installation.



**Warning: To reduce the risk of injury, read all instructions**

1. **All work on this product (system design, installation, operation, setting, configuration, and maintenance) must be carried out by qualified personnel. To reduce the risk of electric shock, do not perform any servicing other than those specified in the operating instructions unless you are qualified to do so.**
2. Read all instructions before installing. For electrical work, follow all local and national wiring standards, regulations, and these installation instructions.
3. Make sure the inverter is properly grounded. All wiring should be in accordance with the National Electrical Code (NEC), ANSI/NFPA 70.
4. The inverter and system can inter-connect with the utility grid only if the utility provider permits. Consult with your local AHJ (Authority Having Jurisdiction) before installing this product for any additional regulations and requirements for your area.
5. All warning labels and nameplates on this inverter should be clearly visible and must not be removed or covered.
6. The installer should consider the safety of future users when choosing the inverter's correct position and location as specified in this manual.
7. Please keep children away from touching or misusing the inverter and relevant systems.
8. **Beware!** The inverter and some parts of the system can be hot when in use, please do not touch the inverter's surface or most of the parts when they are operating. During operation, only the LCD and buttons should be touched.

## DISCLAIMER

EG4 reserves the right to make changes to the material herein at any time without notice. Please refer to [www.eg4electronics.com](http://www.eg4electronics.com) for the most updated version of our manuals/spec sheets.

## 3. BRIEF INTRODUCTION

### 3.1 INVERTER FEATURES

- Applicable for purely off-grid inverter/backup power situations.
- Integrated with 2 MPPT solar charge controllers with maximum PV input of 480V with an optimal range of 120VDC-385VDC.
- Additional safety features such as PV Arc Fault Protection and PV Ground Fault Protection.
- Rated for 6kW output, with a power factor of 1.
- Able to run without battery in off-grid mode.
- Able to utilize generators with dedicated generator terminals.
- Supports paralleling for up to 16 inverters.
- Supports CAN/RS485 for Lithium battery communications.
- Features remote monitoring and firmware updates via mobile phone app or monitoring system website.

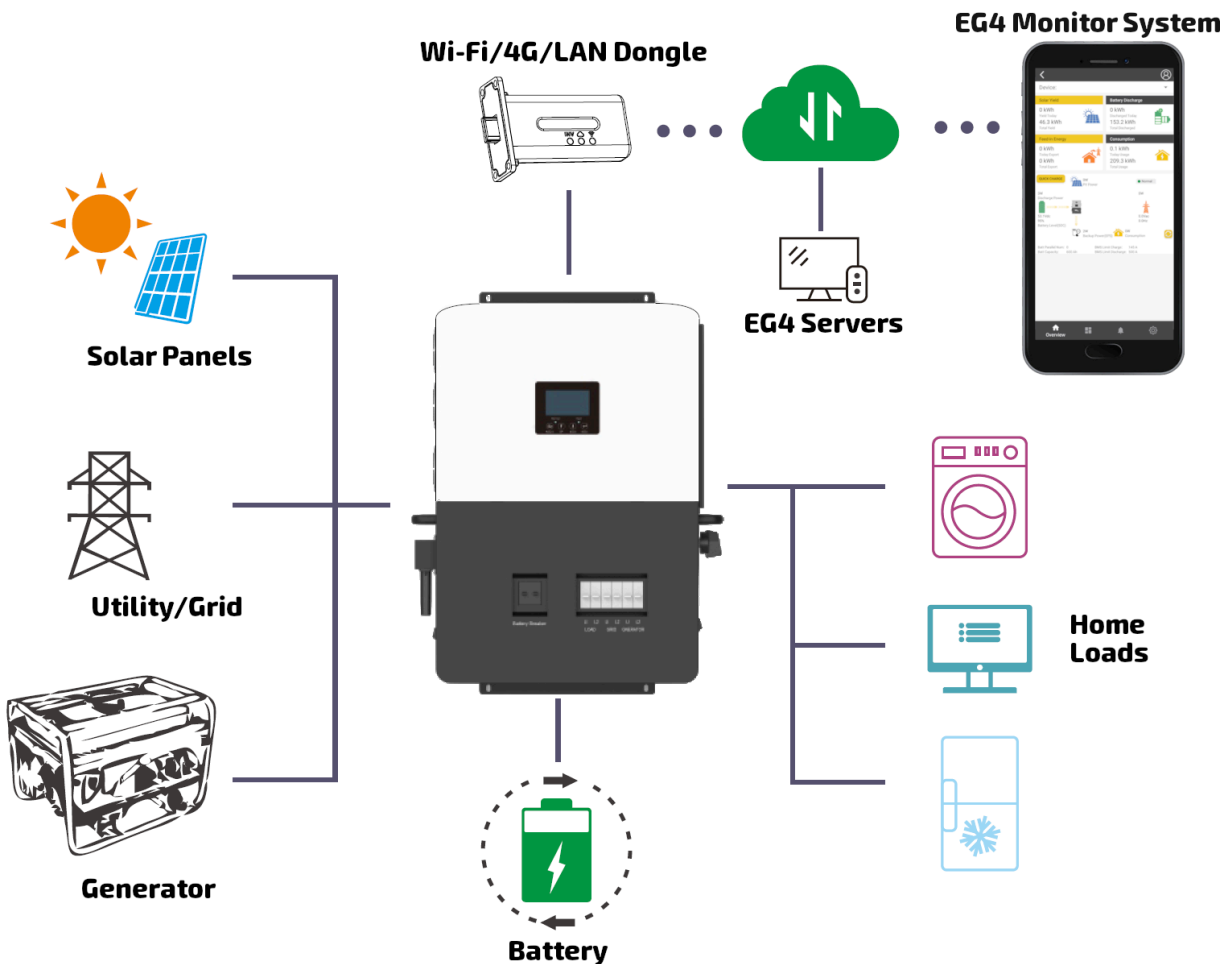

## 3.2 INVERTER INTERFACE

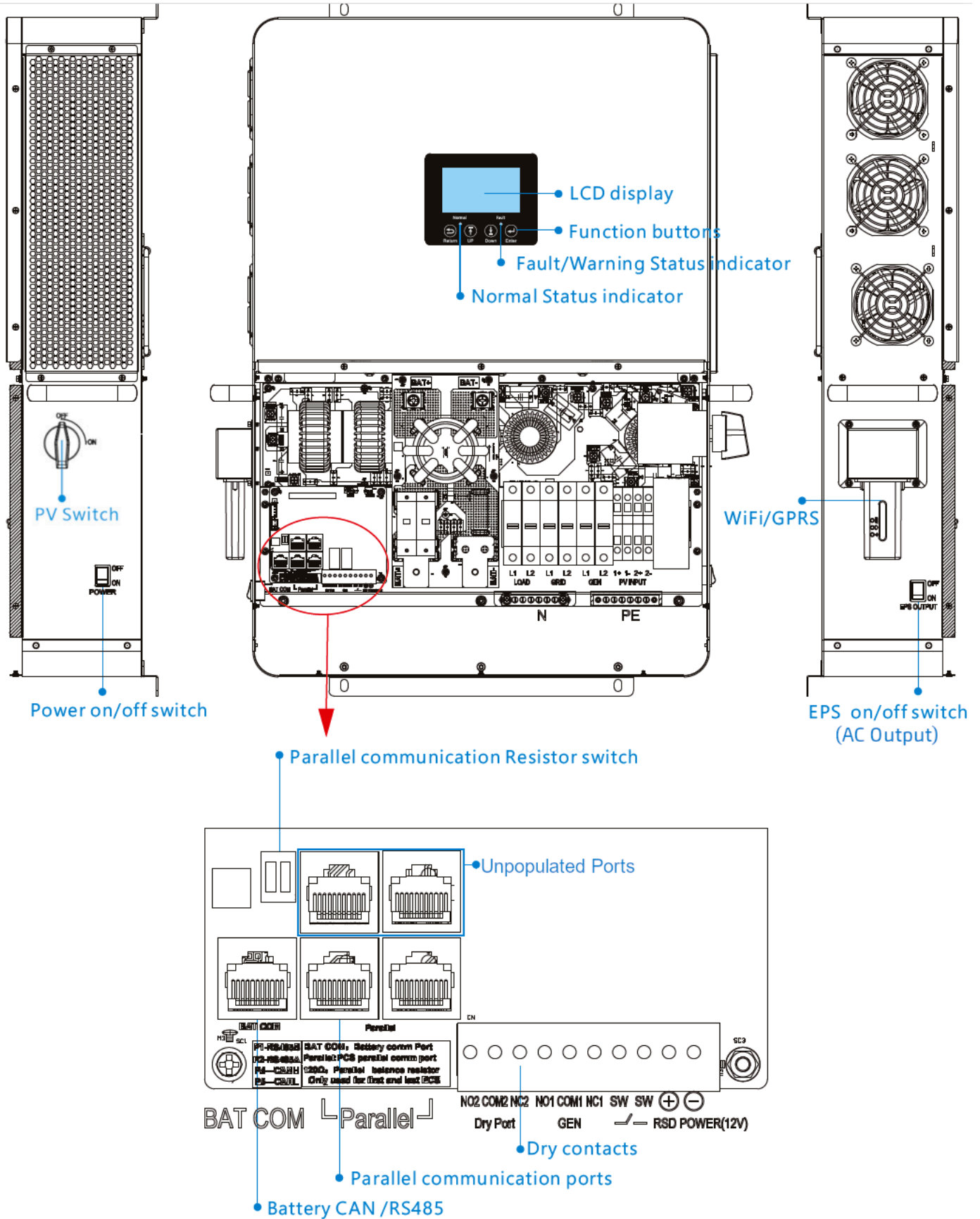



## 3.3 STORAGE INFORMATION

If placing the inverter into storage before installation, please keep the following factors in mind when selecting a storage location.

1. The inverter and its components must be stored in its original packaging.
2. The storage temperature should remain within  $-13 - 140^{\circ}\text{F}$  ( $-25 - 60^{\circ}\text{C}$ ), and humidity within 0-85%.
3. The packing should remain upright.
4. **Do not** store the inverter or its packaging in direct sunlight or where there is potential for water to accumulate.
5. See diagram below for an example.

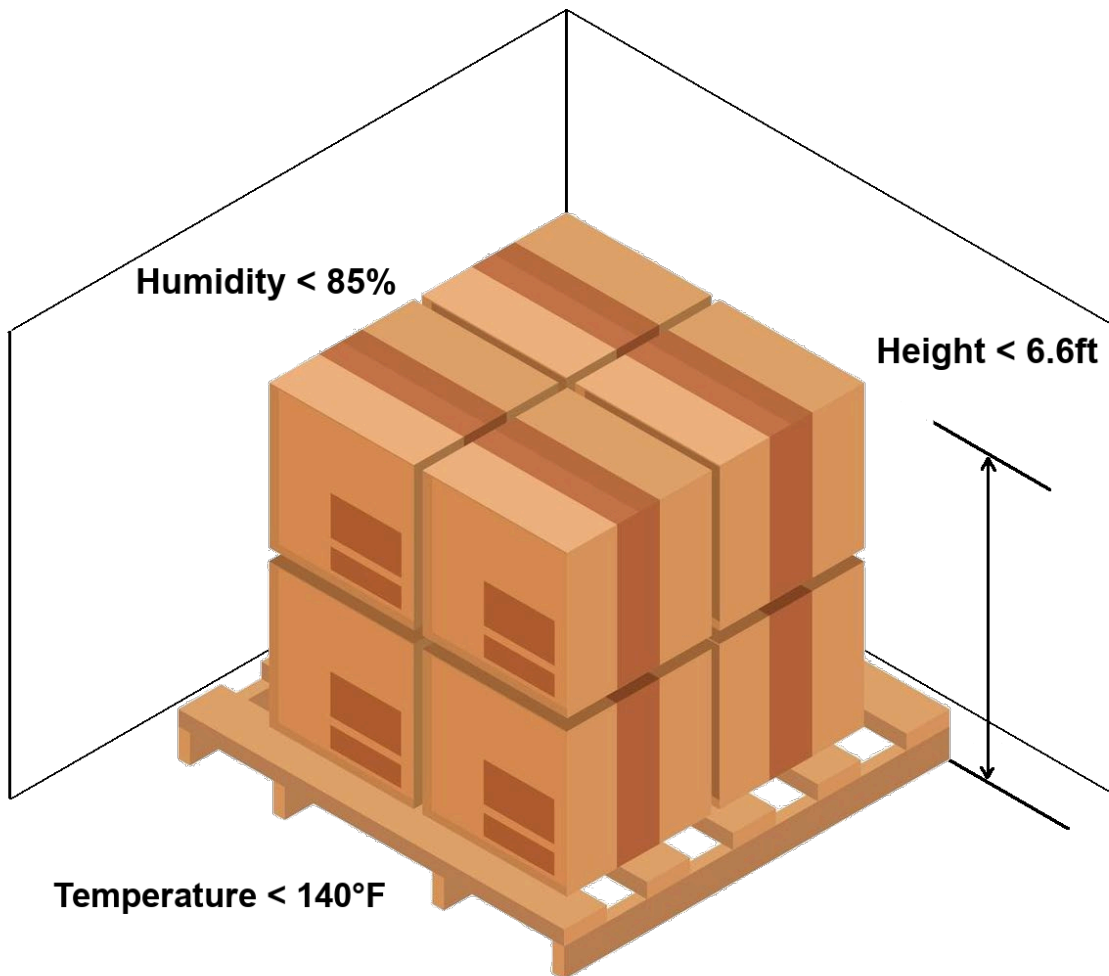





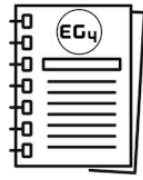

## 4. INSTALLATION

### 4.1 PACKING LIST

When the product is unpacked, the contents should match those listed below:  
 Pictures are for reference only, subject to our available products.

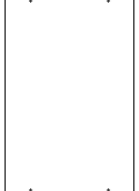
### 4.2 LOCATION SELECTION AND INSTALLATION

 <p><b>6000XP Inverter</b></p>	 <p><b>User Manual</b></p>	 <p><b>Expansion Screws and Tubes (4)</b></p>	 <p><b>Wi-Fi Module</b></p>	 <p><b>Cross Head Screws</b>                  M6 x 16 (2)                  M3 x 10 (4)</p>
 <p><b>Mounting Template</b></p>	 <p><b>Inverter to Battery Comm. Cable (78in. length) (1)</b></p>	 <p><b>Inverter to Inverter Comm. Cable (78in. length) (1)</b></p>		

#### 4.2.1 REQUIREMENTS FOR INSTALLATION LOCATION

1. The mounting wall should be strong enough to bear the weight of the inverter.
2. Please maintain the minimum clearances presented below for adequate heat dissipation.
3. The inverter should be installed upright on a vertical surface.

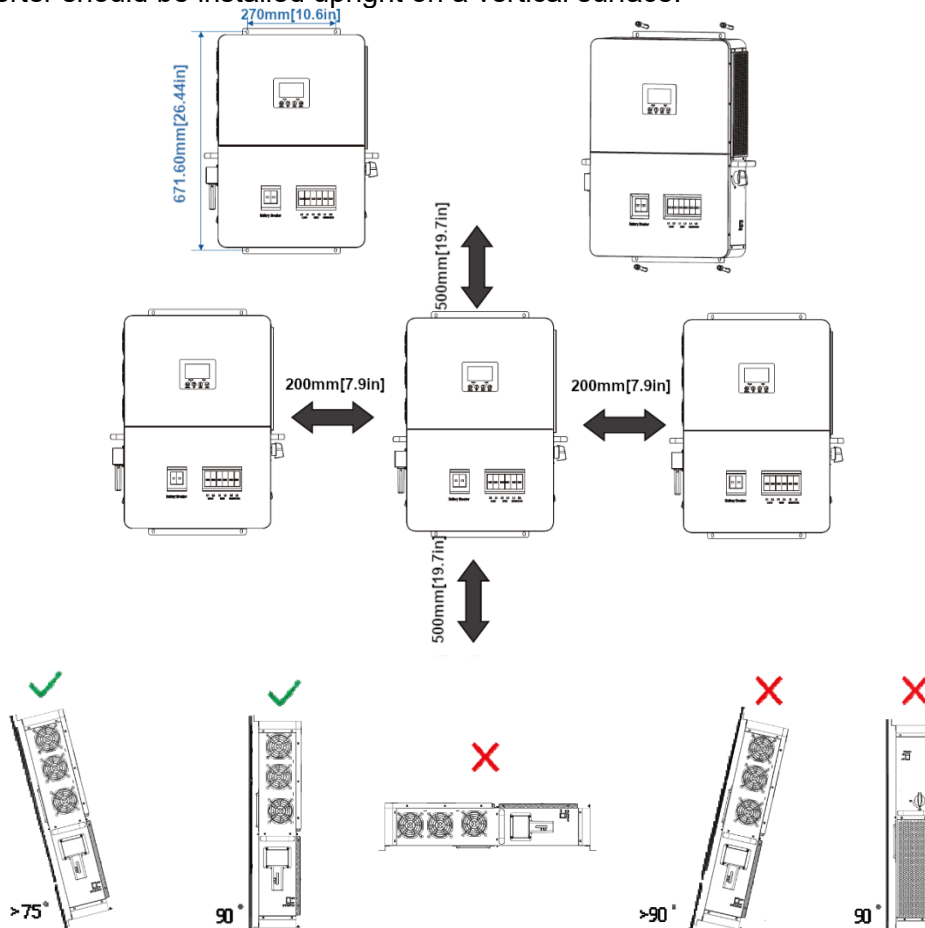

## 4.2.2 INSTALLING THE INVERTER

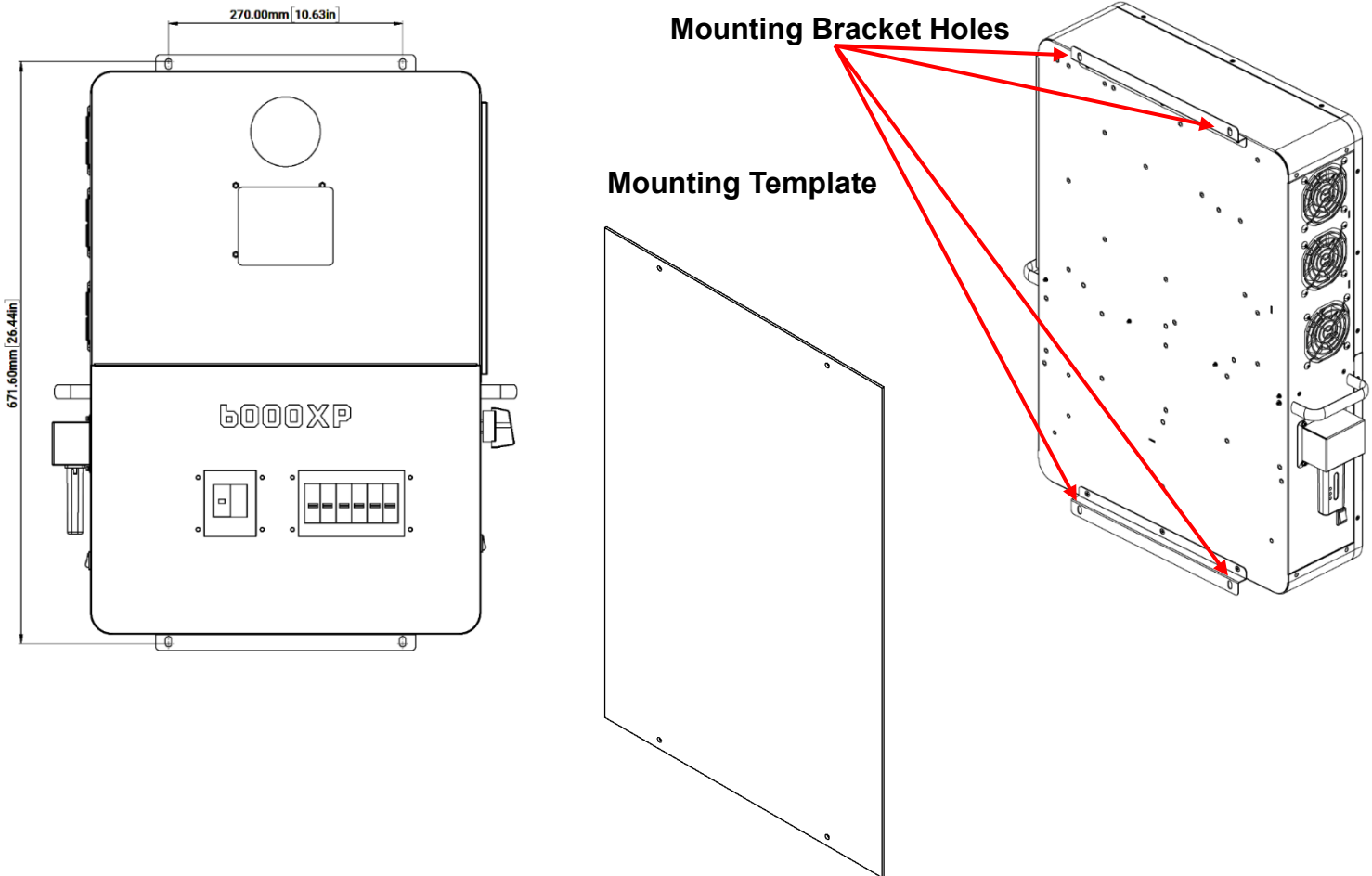

The inverter is designed to be wall-mounted and should be installed on a vertical, solid, mounting surface, such as brick, concrete, or other **non-combustible** material. Two or more people may be needed to install the inverter due to its weight (≈53 lbs).

## 4.2.3 MOUNTING STEPS

**Note:** Ensure the surface you are mounting the inverter to can support the weight of the unit, **and** has proper spacing as per the diagram on the previous page.

1. Identify where the inverter's final placement will be.
2. Use the included cardboard template to mark where the mounting screws will be installed.
3. Using a ruler, ensure the top left to top right marks are ≈10.63in. apart, along with the bottom left to bottom right marks.
4. Using a ruler, ensure the top left to bottom left marks are ≈26.4in., along with the top right to bottom right marks.
5. Place the inverter over the holes to ensure they line up with the bracket plate. Upon confirmation, proceed to next step.
6. Drill 5/16 in. (8 mm) diameter holes on the marks, making sure the holes are deeper than 2 in. (50 mm).
7. Insert the expansion bolts into the drilled holes.
8. Use the corresponding nuts and washers (packaged together with the expansion bolts) to install and affix the inverter onto the wall. Use the team-lift technique to ensure the user's safety.

## 4.3 CONNECTION OVERVIEW

### 4.3.1 SYSTEM CONNECTIONS

Before connecting *any* wiring, please remove the bottom cover by removing the 7 screws as shown below.

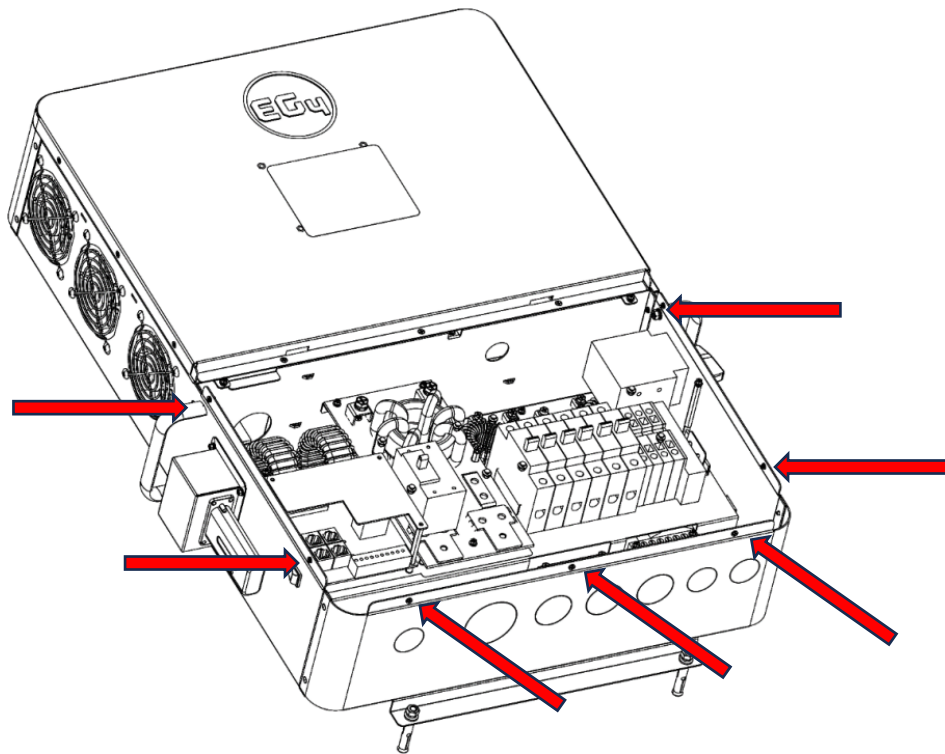

## 4.4 PV CONNECTION

### 4.4.1 CONNECTING PV TO THE INVERTER

Install a separate DC circuit breaker/isolator between the inverter and PV module(s). The recommended DC breaker is a 4-pole 600V/20A. The minimum isolator to house both positives and both negatives if using two independent strings. If only using 1 string, a 2 pole 600V/20A isolator/breaker is recommended. The recommended cable size for the PV connection(s) is 10 AWG (4mm<sup>2</sup>) torqued to 1.2 Nm.

Consult with your installer to ensure that appropriate cable sizing is used due to various factors such as voltage drop and Voc.

PV Cable Size	Min. PV Disconnect/Isolator Spec	Torque Specs - PV to Inverter
10 AWG – 6 AWG (Max) (6mm <sup>2</sup> - 16mm <sup>2</sup> )	600V/20A	1.2Nm



## Reminder!

Verify the lowest ambient temperature of the installation location. The rated Voc on the solar module nameplate is obtained at STC (77°F/25°C). As the ambient temperature drops, the solar module Voc increases. Please ensure the maximum solar string voltage, corrected at the lowest temperature, **does not exceed** the inverter's maximum input voltage of 480VDC.

PV Input Data	Description	Parameter
DC Input Voltage Range	Range required for the unit to operate up to max input	100–480 VDC
Load Output Minimum Voltage	Minimum voltage needed to output power on Load side	>140 VDC
MPP Operating Voltage Range	Range where the MPPT can track	120–385 VDC
Nominal MPPT Voltage	The MPPT will operate most optimally at this voltage	320 VDC
Nominal MPPT Amperage	The MPPT will operate most optimally at this amperage	17A
Maximum MPPT Amperage	The MPPT can accept up to this amperage (clipping will occur past this value)	25A
Maximum Utilized Solar Power	Watts the unit can utilize from array after considering all power loss factors	8kW

### 4.4.2 STRING SIZING

When solar modules are put in a series string, the voltage multiplies times the number of modules and the amperage stays the same as each module.

**For example:** Using solar modules that have a 40VDC Voc (@77°F) with a Max Power amperage of 10 Amps (Imp) - 10 modules wired in a series string would have a Voc of 400 VDC (@77°F) and a string amperage of 10 Amps. When the temperature lowers, the voltage can rise above the maximum allowed by the inverter and damage will result.

**CAUTION:** To determine how many modules you can have per string; first verify the lowest possible ambient temperature of the installation location. Next, find the rated Voc, Vmp, Isc and Imp of the solar module at 77°F and the temperature coefficients for voltage and power. Then calculate highest possible Voc for the entire string when the ambient temperature falls to the lowest possible ambient temperature upon sunrise. To make this calculation, use a string calculator or consult your solar designer or solar electrician.



## DANGER!

**Damage WILL Occur if the string voltage exceeds the inverter's maximum input voltage of 480VDC!**

Finally, calculate the maximum current of the string (Isc) so as not to exceed the Inverter's MPPT circuit ratings of 25A (see note at end of section). Double check if the calculated Vmp range is within the 120-385 VDC optimal MPPT circuit operating range. It is recommended to consult a solar designer for assistance.

**FOR ALL MODULES, THE CALCULATIONS NEED TO BE PERFORMED OR VERIFIED BY USING A STRING CALCULATOR OR CONSULTING A PROFESSIONAL.**

The inverter has two MPPT PV charging circuits. MPPT #1 and #2 will utilize up to 17 amps, which means two strings can be paralleled for any modules having less than 8.5A (Imp) rating.

When sizing strings for each MPPT, they **MUST** be the same model, brand and # per string (series and parallel).

All panels on a series/parallel string should face the same orientation and be exposed to roughly the same shading across the string. Consideration should be placed on string location and wiring order on the racking to minimize shading effects. One shaded module can disproportionately reduce output for the entire string so avoiding linear strings in favor of rectangular strings can increase output. Optimizers can also achieve this.

**Note:** The array **may** have a higher *I<sub>mp</sub>* than the 17A specified, but the MPPTs may not make full use of the extra current and may lead to component deterioration over time.

## 4.4.3 PV WIRING INSTRUCTIONS

Please follow the steps listed below to ensure proper PV connections.

**Step 1:** Before installing PV wiring into the inverter, please ensure all breakers and disconnects are open (off) and confirm your PV strings are not energized by using a multimeter to ensure there is no DC voltage on the lines. Once that has been verified, please proceed to step 2.

**Step 2:** Strip off 1/4 - 5/16 in. (6 – 8mm) insulation from the PV strings' positive and negative conductors

**Note:** If using fine stranded wire, use ferrules to secure the connections to the inverter.

**Step 3:** Insert the conduit fitting into the openings for the PV connections and tighten from the inside using the counter nut.

**Step 4:** Route the PV conductors through the conduit fitting and into the inverter.

**Step 5:** Secure the PV conductors in place into their respective terminals and torqued to 1.2Nm. Verify the cables are secure by lightly tugging on them.

**Step 6:** Ensure the conduit and conduit fittings are fastened reliably, and the cable entry holes are sealed.

**Note:** All exposed metal parts of the system must be grounded regardless of voltage, including solar panel frames.

**DO NOT GROUND NEGATIVE PV LINES, ONLY SOLAR PANEL FRAMES.**

Please see the diagram below for PV terminal labeling.

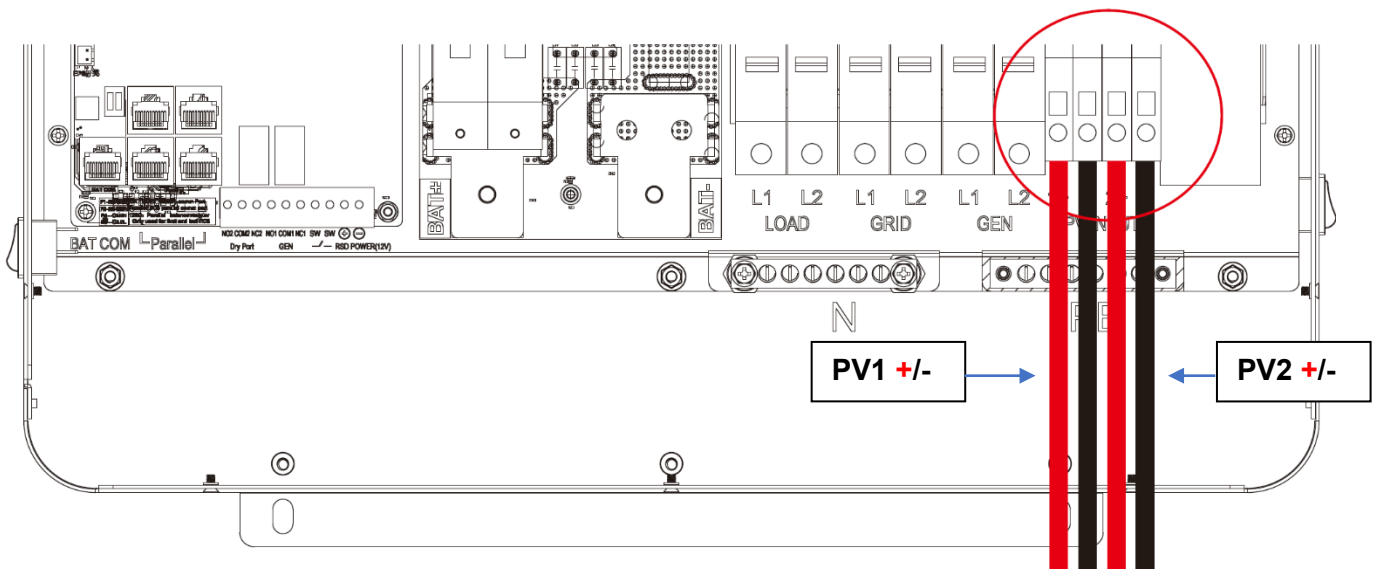

## 4.5 BATTERY CONNECTION

The EG4 6000XP can utilize either Lithium or Lead-Acid batteries. There is a combination of settings that need to be changed depending on the battery type.

### 4.5.1 BATTERY CABLE CONNECTION

**Note: For Lead Acid batteries, the recommended charge current is 0.2C**

Follow the steps below to properly connect your battery wires.

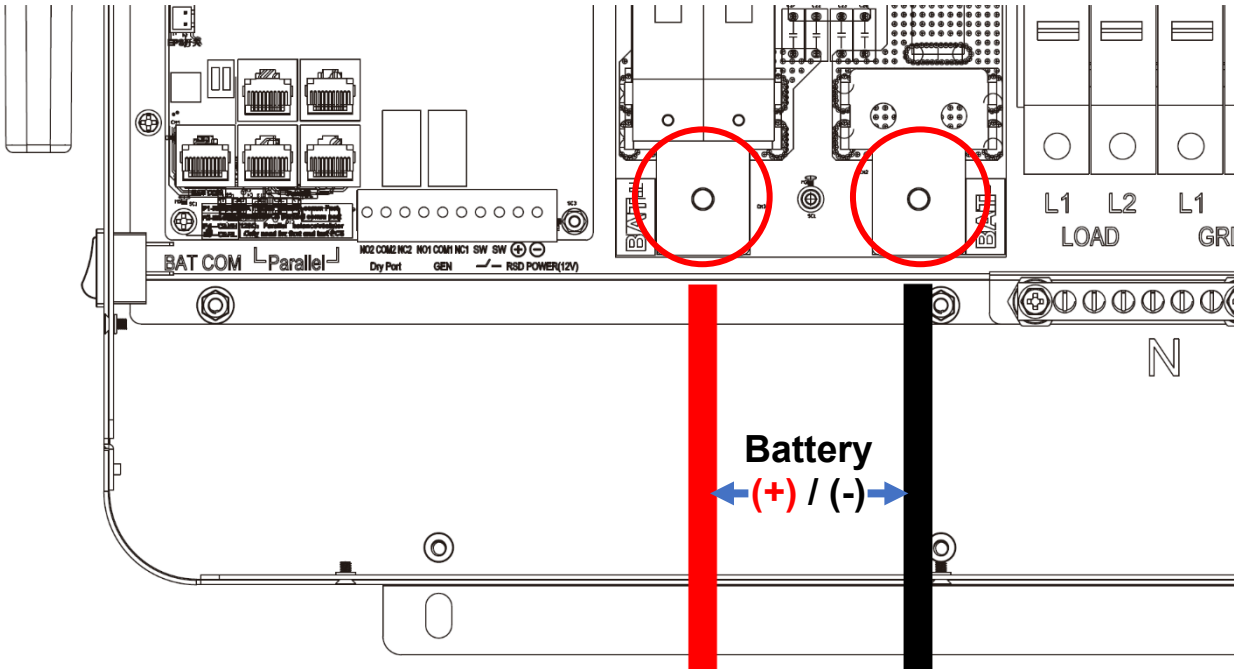

**Step 1:** Place all breakers in the open (off) position before connecting or disconnecting wires. Ensure that there is no DC voltage present with a voltmeter.

**Step 2:** Assemble battery ring terminal based on recommended battery cable and terminal size (see table below).

**Step 3:** Connect all batteries as the unit requires.

**Note:** If using a battery rack, ensure that all battery connections are installed properly before proceeding. Please refer to battery manual for more information.

**Step 4:** Connect your positive battery cable (RED) to the positive battery terminal (BAT+) and your negative battery cable (Black) to your negative battery terminal (BAT-) with a torque rating of 4~5 Nm (≈36 in-lbs. - 45 in-lbs.) per connection.

**Step 5:** Be sure not to cross polarize, as this **will damage** the equipment.

**Note: The recommended battery capacity of one 6000XP inverter is ≥200AH**

The recommended battery cable and terminal size are as follows:

Maximum Amperage	Battery Capacity	Wire Size	Ring Terminal			Torque Value	Terminal Temperature Rating
			Cable (mm <sup>2</sup> )	Dimensions			
				Depth	Length		
125A*	≥200AH	1 AWG	38	6.4mm(1/2in)	39.2mm(1.5in)	80 Nm	-40 - +248°F (-40° - +120°C)

\*115A @ 48VDC (AC), 125A @48VDC (PV)

## 4.5.2 LITHIUM BATTERY COMMUNICATIONS

Upon successful installation of your batteries, follow the next steps to enable closed-loop communications (with compatible battery modules) between batteries and inverter.

1. Connect either the CAN or RS485 (depending on make/model of battery) communications cable between inverter and battery. See diagram below.

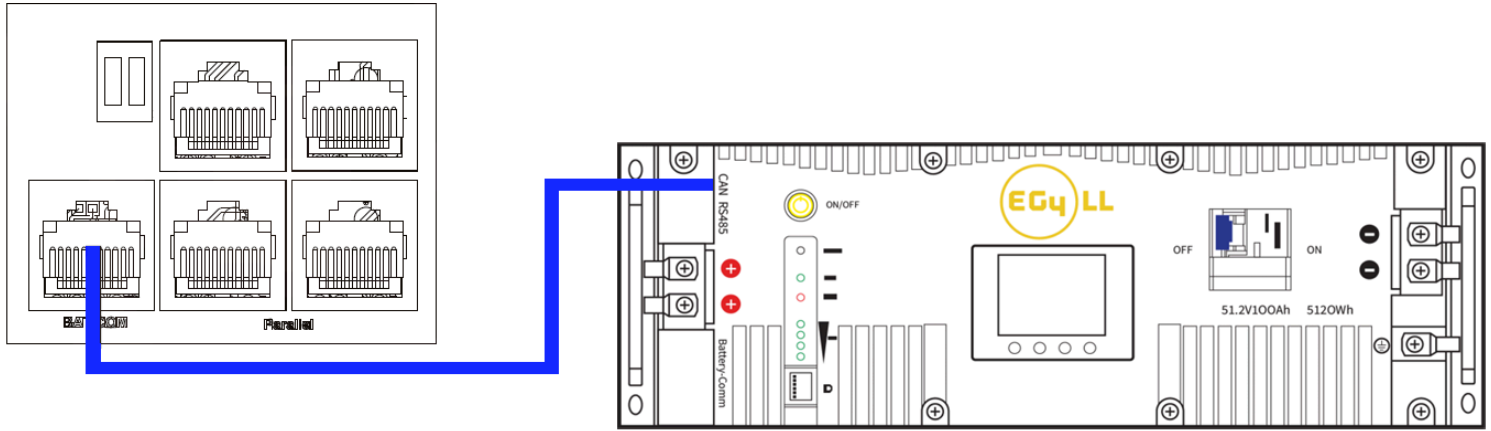

2. For the inverter to communicate with the battery BMS, you must change setting 3 to “Li-ion”. The inverter will then switch to a secondary setting. Here, you select your make/model of battery and press enter to register the change. For EG4 batteries, you would select “0” after confirming “Li-ion” as the battery type.

**Note:** If needing to extend your inverter to battery communication cable or create your own, please refer to the following table for the inverter pinout descriptions.

For battery specific pinouts, please refer to the respective battery user manual.

PIN #		1	2	3	4	5	6	7	8
CAN	Pin	X	X	X	BMS_CAN H	BMS_CAN L	X	X	X
RS485	Description	BMS_485 B	BMS_485 A	X	X	X	GND		

## 4.6 AC WIRING INFORMATION

When sizing AC wires, please adhere to the following information.

### AC Cable Requirements:

Terminal Connection	Wire Size	Torque Values
GRID	8 AWG (10mm <sup>2</sup> )	2 Nm (18 in. lbs.)
GEN	8 AWG (10mm <sup>2</sup> )	2 Nm (18 in. lbs.)
LOAD	8 AWG (10mm <sup>2</sup> )	2 Nm (18 in. lbs.)

### Ground-Neutral Bonding

The information below describes the nature of the ground and neutral in the inverter and their relationship to the system. Always consult with your installer or a licensed electrician to ensure that the right configuration is being used:

- The neutral line is a solid connection between AC input and AC output (known as a Common Neutral Architecture).
- The neutral line between the AC input and AC output is never disconnected.



- This architecture assumes there is a single neutral-ground bond in the system. Typically, the neutral-ground bond for a system will be at the first means of disconnect for the grid. However, if there is no neutral-ground bond in the system, the 6000XP can be configured to create the bond internally (see setting 26).

**Note:** This is not a dynamic bond. It is **always** enabled or **always** disabled.

## 4.6.1 STEPS FOR AC CONNECTION

Please follow the steps outlined below to ensure proper AC Input/Output connections.

**Note:** Always be sure to connect your AC Output ground wire to the Ground terminal bus (labelled PE in the diagram) first before installing your AC Outputs L1 and L2.

**Step 1:** Before installation of **any** wiring, please ensure all breakers are open (off) before making any connections. Use a multimeter to confirm your AC Input lines (L1, L2 and neutral) are not energized.

**Step 2:** Strip off 5/16-3/8 in. (8-10 mm) insulation from the AC cables.

**Note:** If using fine stranded wire, use ferrules to secure the connection.

**Step 3:** Fasten the AC Input wires into their respective terminals using the proper torque.

### Standard US Wiring:

L1 – Black  
L2 – Red  
Neutral – White  
Ground – Green

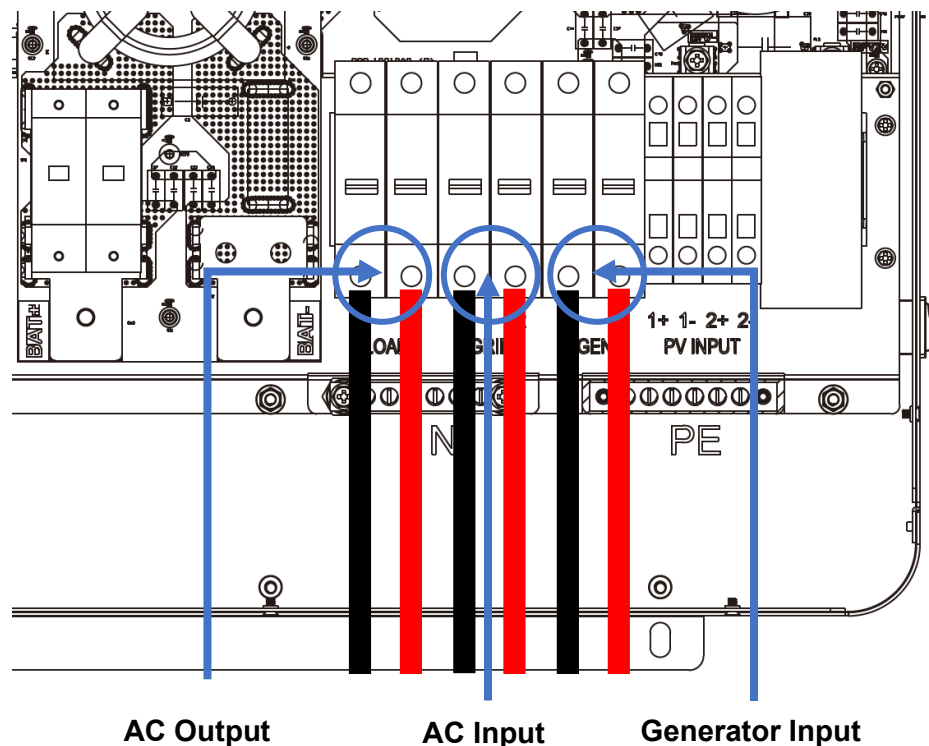

## ! Reminder!

After connecting all AC wiring, put the built-in LOAD breaker back to the ON position before providing power to the load.

## 4.7 WORKING WITH A GENERATOR

### 4.7.1 GENERATOR SYSTEM CONNECTION

The EG4 6000XP can utilize a generator for backup power in the case of Grid failure. When sizing generators to provide both adequate power and frequency, keep in mind that the THD (Total Harmonic Distortion) of the generator must be <3%. It is a good rule of thumb to size your generator for **at least** 1.5x the output of the inverter to allow for powering loads and charging batteries. The table listed below shows the recommended generator capacity for optimal operations.

Number of Inverters in Parallel	Generator Capacity
1	>10kW
2	>15kW
3	>20kW
4	>25kW

When properly wired and configured, the generator, if compatible with remote start, will start automatically when the battery voltage/SOC is lower than the cut-off value or there is a charge request from the BMS. When the generator is running, it will charge the batteries and excess AC power will be diverted to the

AC output (LOAD) to power loads. The pass-through relay on the inverter Generator terminal (GEN) is 30A. When the generator is on, please ensure the total load and charge current does not exceed 30A.

## 4.7.2 INTEGRATED DRY CONTACTS

This inverter has two dry contact connections that can be used to remotely enable external devices such as a generator. The Dry Port (NO2, COM2) can be used to remotely enable an external device when the battery voltage reaches a pre-set warning level. Similarly, the GEN Port (NO1, COM1) can be used to remotely start a generator. To do so, the generator start signal must be connected to the inverter GEN contacts, NO1 and COM1. The following table shows the dry contact status under various system conditions.

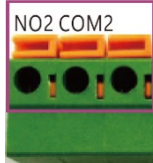
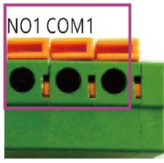
Inverter Status	Condition		Dry Port Status	GEN Port Status
				
Power Off	Inverter is off and no output is powered		Open	Open
Power On	Without Grid	Battery Voltage/SOC < Generator Charge Start Voltage/SOC	Closed	Closed
		Battery Voltage/SOC > Generator Charge Stop Voltage/SOC	Open	Open
	With Grid	Battery Voltage/SOC < Generator Charge Start Voltage/SOC	Closed	Open
		Battery Voltage/SOC > Generator Charge Stop Voltage/SOC	Open	Open

**Note:** NO = Normally Open, COM = Common

Dry Port and GEN relay maximum specification: 250VAC, 5A

## 4.7.3 GENERATOR AC CONNECTIONS

Please follow the steps listed below to ensure your Generator connections are installed correctly.

**Note:** If running more than one inverter in the system, you must wire the generator to provide power to every inverter running in parallel for the inverters to function as intended.

**Step 1:** Before making any wiring connections, be sure to have the inverter(s) powered off, the generator powered off, and all circuit breakers open (off) to prevent damage to the unit.

**Step 2:** Properly identify the generator's output lines. By US wiring standards, L1 wire will be black, L2 will be red, Neutral will be white, and ground will be green. Once identified, remove ≈10mm from the insulation sleeve on the wires.

**Step 3:** Ground the generator's output ground to the Ground Bus (labelled PE) of the inverter.

**Step 4:** Install L1 to the GEN port's L1 terminal, then install L2 to the GEN port's L2 terminal. Next, fasten the Neutral wire from your generator into the N-BUS (Neutral Bus).

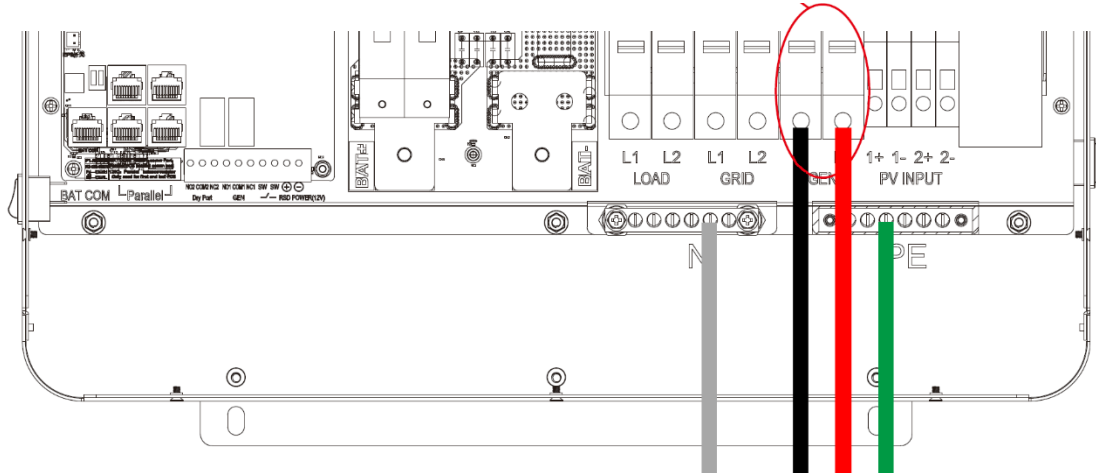

## 4.8 GENERATOR START AND STOP SETTINGS

Using the EG4 Monitoring Software, go to the “Maintenance” page where “Remote Set” will be selected automatically. Scroll down to the “Generator Charge” section and select the “Generator Charge Type” (see screenshot below). Normally, lead-acid batteries are charged according to voltage and Lithium batteries are charged according to SOC.

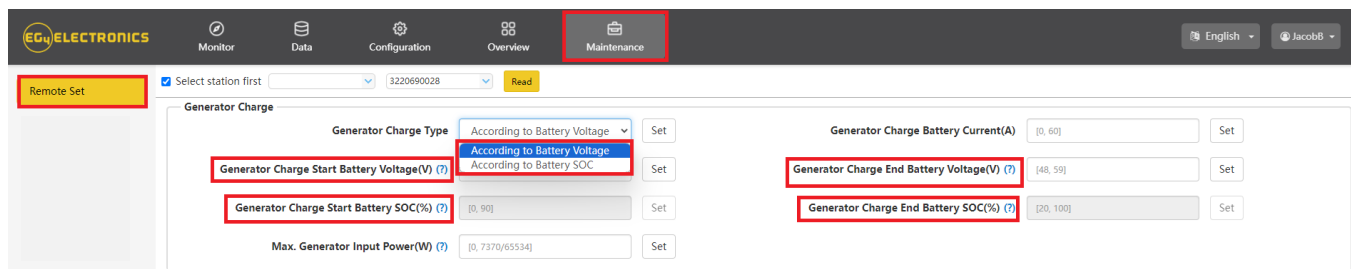

### Generator Start Conditions:

The generator will start when utility fails and one of the following conditions is met:

- The battery is discharged to the cut-off setting or
- There is a force charge request from battery or
- The battery voltage or SOC is lower than the “Generator Charge Start Battery Volt/SOC” setting

### Generator Stop Conditions:

When battery voltage or SOC is higher than the “Generator Charge End Battery Volt/SOC” settings.

## 4.9 OFF-GRID

The 6000XP Inverter can fully function in Off-Grid only mode. It does not need the utility or generator to function. Purely off-grid systems that do not have access to the utility should strongly consider having a 2-wire start backup generator for extended cloudy periods (8-12 kW diesel recommended per 6000XP - 8kWs **minimum per inverter**). Off-Grid systems should have robust battery banks sized to ensure multiple days of power and to reduce generator run time.

### 4.9.1 OFF-GRID WIRING

The 6000XP can accept up to 60 Amps (14.4kW) of generator power and will pass through all available power to the loads. Therefore, the Loads subpanel can be sized up to the size of the backup generator with 60 Amp minimum per inverter.

## 4.10 PARALLELING INFORMATION

### 4.10.1 PARALLEL COMMUNICATION CONNECTIONS

The EG4 6000XP inverter supports parallel connections to expand power and energy capacity to suit different usage scenarios. **Up to 16 units can be paralleled to reach a capacity of up to 96kW.** The parallel communication wiring diagrams are shown below. The manual bypass switch connects the loads to LOAD panel as default. If the inverters fail, users can switch the loads to utility.



#### Remember!

Put the **CAN communication PIN** to **ON** status for the first and the last inverter and **OFF** for inverters in between.

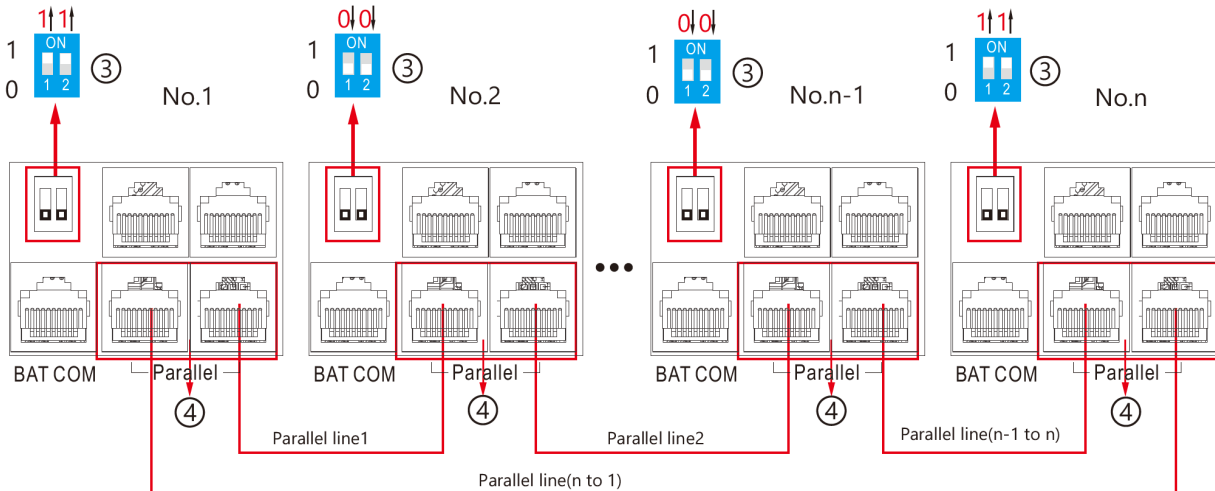

**Note:** Both switches in the “ON” position translates to address 1. Both switches in the “OFF” position translates to address 0.

Please contact your inverter supplier for more detailed guidance on paralleling systems.

### 4.10.2 PARALLEL CONFIGURATION

#### Important notices for parallel system:

- If utilizing the Generator input (GEN), ensure that the generator is connected to all inverters in parallel.
- If not possible to evenly divide solar strings per inverter, it is recommended to have more PV strings on the master inverter.
- The values shown on the LCD of each inverter displays the individual inverter’s contribution to the system, **not the system’s total.**

#### Before commissioning:

1. Verify that all inverters in the system are updated to the latest firmware. Please contact your distributor to confirm you have the latest version.
2. Make sure the power cables and parallel communications cables have been wired correctly, and verify the DIP-switch settings are correct.
3. Ensure your LOAD breakers are off (open). Ensure there is no AC voltage present with a multimeter before proceeding to the next step.
4. Power on the inverters.
5. Navigate to setting 21 to configure phasing.
6. Starting with the inverter with battery to inverter communication cable connected, change setting 21 to 1PH for split-phase parallel. The LCD will then switch to a secondary setting, Parallel Phase. Set the inverter to P1 for phase 1. Repeat this step for all paralleled inverters.
7. Enable “**Battery Shared**” on all inverters in parallel.

8. Ensure all inverters are set to “P1” phase.
9. Ensure the battery to inverter communications cable is properly connected from master battery to inverter.

**Note:** If commissioning a single inverter system, ensure setting 21 is set to NoPL (no parallel), and then finish the commissioning.

### Commissioning Steps:

1. Power on the system per the start-up sequence in section 12.
2. Turn on the battery and make sure the communication works on all units.
3. Check the parallel info via the Home page on the LCD.
4. Before connecting load to load output terminal, check the output of L1 to N, L2 to N and L1 to L2. to ensure no voltage is present.
5. Add some small loads to the load output and verify power output.
6. Finish the commissioning.

**Note:** To determine proper host and slave definition of the inverters, provide power to each before turning on. Turn on the EPS Output (AC Output) on the host inverter first, to designate it as host. Power on each inverter paralleled past the host to define them as slaves. On the main inverter display, press “down” three times, then check the numbers & letters in the top left. Host inverter should read “1P-H:P1: 1”, and slave should read “1P-S:P1: 1”.

## 5. END USER SETTINGS

The EG4 Monitor Software can be used to configure the desired functionality of the 6000XP Inverter. The following sections describe the different fields in the Monitor Software GUI and their definitions for those with an end-user account.

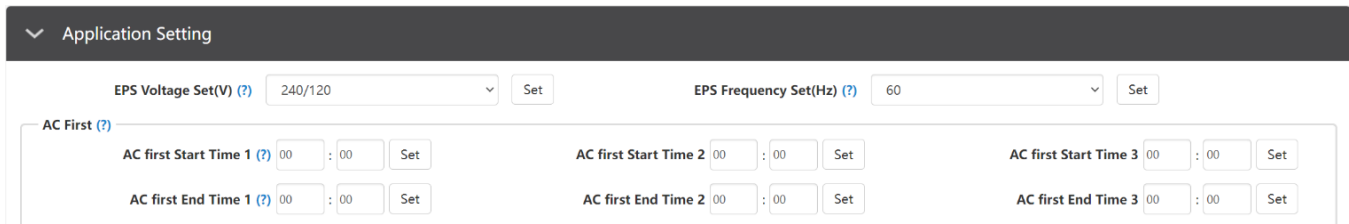

The screenshot shows the 'Application Setting' interface. At the top, there are two dropdown menus: 'EPS Voltage Set(V) (?)' with a value of '240/120' and 'EPS Frequency Set(Hz) (?)' with a value of '60'. Below these are six time-setting fields under the 'AC First (?)' section, arranged in two rows and three columns. Each field consists of a label, a time input (HH:MM), and a 'Set' button. The labels are: 'AC first Start Time 1', 'AC first Start Time 2', 'AC first Start Time 3' in the top row, and 'AC first End Time 1', 'AC first End Time 2', 'AC first End Time 3' in the bottom row. All time inputs are currently set to '00 : 00'.

### 5.1 APPLICATION SETTING

- **EPS Voltage Set(V):** Set the voltage of the inverter’s output.
- **EPS Frequency Set(Hz):** Set the frequency of the inverter’s output.

#### AC First

- **AC first Start Time 1, 2, 3:** Set the start time for when inverter passes through from grid to loads.
- **AC first End Time 1, 2, 3:** Set the end time for when inverter passes through from grid to loads.

## 5.2 CHARGE SETTING

▼ Charge Setting

Charge Current Limit(Adc) (?)

Lead Acid

Charge Voltage(V) (?)

AC Charge

AC Charge (?)        AC Charge Battery Current(A) (?)

AC Charge Start Time 1  :        AC Charge Start Time 2  :        AC Charge Start Time 3  :

AC Charge End Time 1  :        AC Charge End Time 2  :        AC Charge End Time 3  :

AC Charge Start Battery Voltage(V) (?)        AC Charge End Battery Voltage(V) (?)

AC Charge Start Battery SOC(%) (?)        AC Charge End Battery SOC(%) (?)

Generator Charge

Generator Charge Type        Generator Charge Battery Current(A)

Generator Charge Start Battery Voltage(V) (?)        Generator Charge End Battery Voltage(V) (?)

Generator Charge Start Battery SOC(%) (?)        Generator Charge End Battery SOC(%) (?)

Max. Generator Input Power(W) (?)

- **Charge Current Limit(A):** The maximum charge current limitation of the entire system in DC Amps.

### Lead Acid

- **Charge Voltage(V):** Set bulk charging voltage for Lead Acid batteries.

### AC Charge

- **AC Charge:** Utility charge configuration. If users want to use grid power to charge their battery, then they can enable 'AC Charge'. Configure setting by Time, Voltage, SOC, Time & Voltage or Time & SOC. Up to 3 timeslots can be configured via the *AC Charge Start Time 1, 2 and 3* settings shown above.
- **AC Charge Battery Current(A):** Set AC Charge Current limit for grid to batteries.
- **AC Charge Start Battery Voltage(V):** Begin charging from grid when batteries reach this voltage. (If set to charge by Voltage)
- **AC Charge End Battery Voltage(V):** Stop charging from grid when batteries reach this voltage. (If set to charge by Voltage)
- **AC Charge Start Battery SOC(%):** Begin charging from grid when batteries reach this SOC%. (If set to charge by SOC)
- **AC Charge End Battery SOC(%):** Stop charging from grid when batteries reach this SOC%. (If set to charge by SOC)

#### 5.2.1 GENERATOR CHARGE

- **Generator Charge Type:** Set generator charge type by either Voltage or SOC%.
- **Generator Charge Battery Current(A):** Set maximum amperage charge from generator.
- **Generator Charge Start Battery Voltage(V):** Set Voltage which generator will start charging batteries.
- **Generator Charge End Battery Voltage(V):** Set Voltage which generator will stop charging batteries.
- **Generator Charge Start Battery SOC(%):** Set SOC% which generator will start charging batteries.
- **Generator Charge End Battery SOC(%):** Set SOC% which generator will stop charging batteries.

- **Max. Generator Input Power(W):** Set the maximum power(W) the inverter will pull from generator for charging.

## 5.3 DISCHARGE SETTING

Discharge Setting

Discharge Control (?) <span style="border: 1px solid #ccc; padding: 2px;">According to SOC</span> <span style="float: right; border: 1px solid #ccc; padding: 2px;">Set</span>	Discharge Current Limit(Adc) (?) <span style="border: 1px solid #ccc; padding: 2px;">140</span> <span style="float: right; border: 1px solid #ccc; padding: 2px;">Set</span>
Discharge Cut-off Voltage(V) (?) <span style="border: 1px solid #ccc; padding: 2px;">42</span> <span style="float: right; border: 1px solid #ccc; padding: 2px;">Set</span>	Discharge Cut-off SOC(%) (?) <span style="border: 1px solid #ccc; padding: 2px;">15</span> <span style="float: right; border: 1px solid #ccc; padding: 2px;">Set</span>
On Grid EOD Voltage(V) (?) <span style="border: 1px solid #ccc; padding: 2px;">42</span> <span style="float: right; border: 1px solid #ccc; padding: 2px;">Set</span>	On Grid EOD SOC(%) (?) <span style="border: 1px solid #ccc; padding: 2px;">15</span> <span style="float: right; border: 1px solid #ccc; padding: 2px;">Set</span>

- **Discharge Control:** Set Voltage/SOC to configure stop time for battery discharge.
- **Discharge Current Limit(Adc):** Set the limit of battery discharge current.
- **Discharge Cut-off Voltage(V)/SOC(%):** Set when batteries stop discharging to power loads via Voltage/SOC.
- **On Grid EOD Voltage(V)/SOC(%):** Set when batteries stop discharging to power loads via Voltage/SOC and switch to have AC power loads/charge batteries.

## 5.4 RESET

Reset

All to Default Reset

- **Reset:** Reset all settings to factory default. *Be sure to keep track of what changes need to be made before powering the system back on!*

## 6. INSTALLER SETTINGS

The EG4 Monitor Software can be used to configure the desired functionality of the 6000XP Inverter. The following sections describe the different fields in the Monitor Software GUI and their definitions for those with Installer account access.

### 6.1 COMMON SETTING

Common Setting

Time (?) <span style="border: 1px solid #ccc; padding: 2px;">yyyy-MM-dd HH:mm:ss</span> <span style="float: right; border: 1px solid #ccc; padding: 2px;">Set</span>	PV Input Mode <span style="border: 1px solid #ccc; padding: 2px;">0: DC source mode</span> <span style="float: right; border: 1px solid #ccc; padding: 2px;">Set</span>
--	---

Model

Battery Type (?) <span style="border: 1px solid #ccc; padding: 2px;"> </span>	Lead-acid Capacity <span style="border: 1px solid #ccc; padding: 2px;"> </span>
Lithium Type <span style="border: 1px solid #ccc; padding: 2px;"> </span> <span style="float: right; border: 1px solid #ccc; padding: 2px;">Set</span>	

Green Function Enable (?) <span style="border: 1px solid #ccc; padding: 2px;">Enable</span> <span style="border: 1px solid #ccc; padding: 2px;">Disable</span>	Normal / Standby (?) <span style="border: 1px solid #ccc; padding: 2px;">Normal</span> <span style="border: 1px solid #ccc; padding: 2px;">Standby</span>
Battery ECO Enable (?) <span style="border: 1px solid #ccc; padding: 2px;">Enable</span> <span style="border: 1px solid #ccc; padding: 2px;">Disable</span>	Restart Inverter <span style="border: 1px solid #ccc; padding: 2px;">Reset</span>
Buzzer Enable <span style="border: 1px solid #ccc; padding: 2px;">Enable</span> <span style="border: 1px solid #ccc; padding: 2px;">Disable</span>	
ISO Enable <span style="border: 1px solid #ccc; padding: 2px;">Enable</span> <span style="border: 1px solid #ccc; padding: 2px;">Disable</span>	

- **Time:** This is the local date and time.
- **PV Input Mode:** This allows the user to select the PV source for the Inverter. This can be: 0: DC source mode, 3: Two MPPT connects to same string, or 4: Two MPPT connects to different string.
- **Battery Type:** The type of battery being used. Can be set to - 0: No Battery, 1: Lead-acid, or 2: Lithium. **Note:** *It is not recommended to run the system without battery backup.*
- **Lead-acid Capacity:** Select your total battery capacity for lead-acid banks.
- **Lithium Type:** This setting allows the user to select from a list of compatible batteries for closed-loop communications.
- **Green Function Enable:** When enabled, if the inverter load reading is less than 60W for

more than 10 minutes, the inverter output will be cut off.

- **Normal / Standby:** Select Normal for the inverter to operate normally. Select Standby to halt all power input and output.
- **Restart Inverter:** This restarts the inverter.
- **Battery ECO Enable:** When enabled, the inverter will switch to bypass mode if the battery has reached the On-Grid EOD value and AC charging is disabled. The inverter will stay in bypass mode until the battery is being charged again. Switch time can be up to 15ms.
- **Buzzer Enable:** Enable/disable the alarm buzzer.
- **ISO Enable:** Enable/disable PV ground fault circuit interrupter.

## 6.2 APPLICATION SETTING

**NOTE:** The user must also establish the paralleling scheme using Setting 21 in the user interface. 'NoPL' (Not Parallel), '1PH' (Single Phase), '3PH' (Three Phase). See section 11, LCD Settings for details.

Application Setting

EPS Voltage Set(V) (?) <input type="text" value="200/100"/> <input type="button" value="Set"/>	EPS Frequency Set(Hz) (?) <input type="text" value="50"/> <input type="button" value="Set"/>
AC Input Range (?) <input type="text" value="0: APL(Utility Range90~280V 20ms)"/> <input type="button" value="Set"/>	PV Grid Off (?) <input type="button" value="Enable"/> <input type="button" value="Disable"/>
PV Arc <input type="button" value="Enable"/> <input type="button" value="Disable"/>	PV Arc Fault Clear <input type="button" value="Clear"/>
RSD <input type="button" value="Enable"/> <input type="button" value="Disable"/>	N-PE Connect (Inner) <input type="button" value="Enable"/> <input type="button" value="Disable"/>

AC First (?)

AC first Start Time 1 (?) <input type="text" value="0, 23"/> : <input type="text" value="0, 59"/> <input type="button" value="Set"/>	AC first Start Time 2 <input type="text" value="0, 23"/> : <input type="text" value="0, 59"/> <input type="button" value="Set"/>	AC first Start Time 3 <input type="text" value="0, 23"/> : <input type="text" value="0, 59"/> <input type="button" value="Set"/>
AC first End Time 1 (?) <input type="text" value="0, 23"/> : <input type="text" value="0, 59"/> <input type="button" value="Set"/>	AC first End Time 2 <input type="text" value="0, 23"/> : <input type="text" value="0, 59"/> <input type="button" value="Set"/>	AC first End Time 3 <input type="text" value="0, 23"/> : <input type="text" value="0, 59"/> <input type="button" value="Set"/>

Hybrid Setting

PV&AC Take Load Jointly (?) <input type="button" value="Enable"/> <input type="button" value="Disable"/>	Grid CT Connection <input type="button" value="Enable"/> <input type="button" value="Disable"/>
Export to Grid (?) <input type="button" value="Enable"/> <input type="button" value="Disable"/>	Export Power Percent(%) (?) <input type="text" value="0, 100"/> <input type="button" value="Set"/>

Parallel Settings

Set System Type (?) <input type="text"/> <input type="button" value="Set"/>	Battery Shared (?) <input type="button" value="Enable"/> <input type="button" value="Disable"/>
Set Composed Phase (?) <input type="text"/> <input type="button" value="Set"/>	

- **EPS Voltage Set(V):** Set the inverter's output voltage.
- **EPS Frequency Set(Hz):** Set the inverter's output frequency.
- **AC Input Range:** Set the voltage range for AC Input.
- **PV Grid Off:** If the customer wants the system to have Off-Grid functionality without installing any batteries, please enable PV Grid Off. Please note, in this situation the Off-Grid energy is supplied by solar and is not stable. We suggest the customer install battery/batteries to keep the inverter output voltage stable if they want to have Off-Grid function. (Allows system to access the Off-Grid mode when only solar input is available without battery storage). **Note:** *It is not recommended to run the system without battery backup.*
- **PV Arc:** Enables detection of arcs on the PV input circuits to the inverter and provides protection from PV circuit arcs.
- **PV Arc Fault Clear:** Clears any fault detected due to arcs on the PV input circuit to the inverter.
- **RSD:** Enables the Rapid Shut Down feature.
- **N-PE Connect (Inner):** Enable for the AC Neutral (N) and AC Ground (PE) to be bonded.

### AC First

- **AC first Start Time 1-3:** The time at which the Inverter will use only AC to power loads. The range is 00:00 to 23:59.
- **AC first Stop Time 1-3:** The time at which the Inverter will use only AC to power loads. The range is 00:00 to 23:59.



## Parallel Settings

- **Set System Type:** The EG4 6000XP supports paralleling of multiple inverters.
- **Battery Shared:** For paralleled systems, if all inverters connect to same battery bank, Battery Shared must be enabled. The inverter with battery to inverter communication cable connected will broadcast the battery info to all other inverters.

## 6.3 CHARGE SETTING

▼ Charge Setting

Charge Current Limit(Adc) (?)

Lead Acid

Charge Voltage(V) (?)

Floating Voltage(V) (?)

Equalization Voltage(V) (?)

Equalization Period(Days) (?)

Equalization Time(Hours) (?)

AC Charge

AC Charge Based On (?) Disable

AC Charge Battery Current(A) (?)

AC Charge Start Time 1  :

AC Charge Start Time 2  :

AC Charge Start Time 3  :

AC Charge End Time 1  :

AC Charge End Time 2  :

AC Charge End Time 3  :

AC Charge Start Battery Voltage(V) (?)

AC Charge End Battery Voltage(V) (?)

AC Charge Start Battery SOC(%) (?)

AC Charge End Battery SOC(%) (?)

Generator Charge

Generator Charge Type Battery Voltage (According to)

Generator Charge Battery Current(A)

Generator Charge Start Battery Voltage(V) (?)

Generator Charge End Battery Voltage(V) (?)

Generator Charge Start Battery SOC(%) (?)

Generator Charge End Battery SOC(%) (?)

Max. Generator Input Power(W) (?)

- **Charge Current Limit(Adc):** The maximum charge current limitation of the entire system in DC Amps.

## Lead Acid

- **Charge Voltage(V):** Set this according to the battery requirements. Range is 50-59 VDC.
- **Floating Voltage(V):** Set this according to the battery requirements. Range is 50-56 VDC. When using lead-acid batteries, this must be set lower than the 'Charge Voltage' above. When using Lithium batteries in lead-acid mode, this can be set  $\leq$  'Charge Voltage' above.
- **Equalization Voltage(V):** Range is 50-59VDC for lead-acid batteries. When using Lithium batteries in lead-acid mode, this should be set to 0 (zero).
- **Equalization Period(Days):** Range is 0-365 days for lead-acid batteries. When using Lithium batteries in lead-acid mode, this should be set to 0 (zero).
- **Equalization Time(Hours):** ) : Range is 0-24 hours for lead-acid batteries. When using Lithium batteries in lead-acid mode, this should be set to 0 (zero).

## AC Charge

- **AC Charge Based On:** If using AC (i.e., the Grid) to charge the battery; the customer must first select the method of charging. This can be set to charge by "Time", "Voltage", "SOC", "Battery Voltage and Time" or "Battery SOC and Time".
- **AC Charge Battery Current(A):** Set this according to the battery requirements. Range is 0-100 Amps.
- **AC Charge Start Time 1-3:** Start AC Charging according to these time settings.
- **AC Charge End Time 1-3:** Stop AC Charging according to these time settings
- **AC Charge Start Battery Voltage(V):** Battery Voltage at which system will start charging batteries from AC. Set this according to the battery requirements. Range is 38.4-52 VDC.

- **AC Charge End Battery Voltage(V):** Battery Voltage at which system will stop charging batteries from AC. Set this according to the battery requirements. Range is 48-59 VDC.
- **AC Charge Start Battery SOC(%):** Battery % SOC at which system will start charging batteries from AC. Set this according to the battery requirements. Range is 0-90 %.
- **AC Charge End Battery SOC(%):** Battery % SOC at which system will stop charging batteries from AC. Set this according to the battery requirements. Range is 20-100 %.

## Generator Charge

- **Generator Charge Type:** Set Generator charging according to Battery Voltage or Battery SOC.
- **Generator Charge Battery Current(A):** Set Generator battery charging current. Range is 0-60 Amps.
- **Generator Charge Start Battery Voltage(V):** Battery Voltage at which system will start charging batteries from the Generator. Set this according to the battery requirements. Range is 38.4-52 VDC.
- **Generator Charge End Battery Voltage(V):** Battery Voltage at which system will stop charging batteries from the Generator. Set this according to the battery requirements. Range is 48-59 VDC.
- **Generator Charge Start Battery SOC(%):** Battery % SOC at which system will start charging batteries from the Generator. Set this according to the battery requirements. Range is 0-90 %.
- **Generator Charge End Battery SOC(%):** Battery % SOC at which system will stop charging batteries from the Generator. Set this according to the battery requirements. Range is 20-100 %.
- **Max. Generator Input Power(W):** The inverter will limit the power from the generator to 90% of the total generator capability to prevent overloading. Range is 0-7,370 Watts for a single inverter and 0-65,534 Watts for parallel inverters.

## 6.4 DISCHARGE SETTING

▼ Discharge Setting

<p>Discharge Control (?) <input type="text" value="According to Voltage"/> <input type="button" value="Set"/></p> <p>Battery Warning Voltage(V) (?) <input type="text" value="40, 50"/> <input type="button" value="Set"/></p> <p>Discharge Cut-off Voltage(V) (?) <input type="text" value="40, 50"/> <input type="button" value="Set"/></p> <p>On Grid EOD Voltage(V) (?) <input type="text" value="40, 56"/> <input type="button" value="Set"/></p>	<p>Discharge Current Limit(Adc) (?) <input type="text" value="0, 110/4480"/> <input type="button" value="Set"/></p> <p>Battery Warning SOC(%) (?) <input type="text" value="0, 90"/> <input type="button" value="Set"/></p> <p>Discharge Cut-off SOC(%) (?) <input type="text" value="0, 90"/> <input type="button" value="Set"/></p> <p>On Grid EOD SOC(%) (?) <input type="text" value="0, 90"/> <input type="button" value="Set"/></p>
--	---

- **Discharge Control:** Set to 'According to Voltage' when using a lead-acid battery or a Lithium battery in lead-acid mode. Set to 'According to SOC' when using a compatible Lithium battery.
- **Discharge Current Limit(Adc):** Set this according to the battery requirements. Range is 1-110 Amps for a single battery and 1-4480 Amps for paralleled batteries.
- **Battery Warning Voltage(V):** Set this according to the battery requirements. The inverter will display a battery low warning when the battery voltage falls to this value. Range is 40-50 VDC.
- **Battery Warning SOC(%):** Set this according to the battery requirements. The inverter will display a battery low warning when the battery SOC falls to this value. Range is 0-90 %.
- **Discharge Cut-off Voltage(V):** Set this according to the battery requirements. Range is 40-50 VDC.

- **Discharge Cut-off SOC(%)**: Set this according to the battery requirements. Range is 0-90 %
- **On Grid EOD Voltage(V)**: The inverter will stop discharging the battery at this Voltage and will use AC to power loads.
- **On Grid EOD SOC(%)**: The inverter will stop discharging the battery at this SOC and will use AC to power loads.

## 6.5 OTHER SETTING

Other Setting

CT Power Offset(W)	<input type="text" value="[-199, 199]"/>	Set	Batt Volt Sample Disable	<input type="text" value="Internal"/>	Set
Fan 1 Max Speed(%)	<input type="text" value="[50, 100]"/>	Set	Fan 2 Max Speed(%)	<input type="text" value="[50, 100]"/>	Set

- **Batt Volt Sample Disable**: Set to Internal, External or Both Available.
- **Fan 1 Max Speed(%)**: This sets cooling fan 1 max. speed. Range is 50-100%.
- **Fan 2 Max Speed(%)**: This sets cooling fan 2 max. speed. Range is 50-100%.

## 6.6 RESET

Reset

All to Default

- **All to Default**: This resets all settings to factory default values.

**NOTE:** Be sure to keep track of your settings and what changes need to be made before powering the system back on!

## 7. MONITOR SYSTEM SETUP

### 7.1 WI-FI/4G/LAN DONGLE CONNECTION

A Wi-Fi/4G/LAN dongle can be used to monitor the inverter and remotely view the monitoring data on a computer or smart phone. You can attach this module by plugging it in to the 'Wi-Fi' connector on the inverter and securing it with the 4 Phillips head screws. See section 9 for more details regarding dongle setup.

### 7.2 THIRD-PARTY RS485 COMMUNICATION

Meters 485B and 485A can be used when a meter is not connected. These two pins can be used to communicate with the inverter using the RS485 Modbus protocol.

INV485: This interface is shared with the Wi-Fi module. If the Wi-Fi module is not in use, this interface can be used to communicate with the inverter.

Please contact your distributor to get the Modbus protocol for third-party app development.

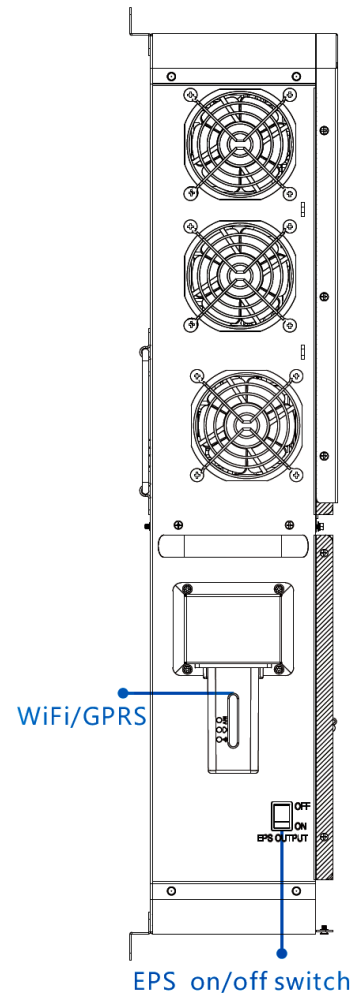

#### **View data on smart phone:**

A QR code with a link to our website with app installation steps can be found on the side of the inverter, or visit our downloads page at [www.eg4electronics.com](http://www.eg4electronics.com) for more information.

## 7.3 ONLINE MONITORING SYSTEM USER INTERFACE

The customer needs to register a monitor account in the monitor system and set a Wi-Fi password for the Wi-Fi dongle before using the EG4 monitor system. The monitoring system may change due to updates, so you may find the following UI descriptions vary from the current pages on the site. If you have any questions, or to create distributor or installer accounts, please contact [support@eg4electronics.com](mailto:support@eg4electronics.com) for assistance. See section 9 for detailed instructions on how to access the EG4 Monitor APP, how to register an account, and how to set a Wi-Fi password.

### 7.3.1 DASHBOARD (MONITOR TAB)

Once your account is created, log in and you will be brought to the main page (Monitor tab) of the monitoring interface.

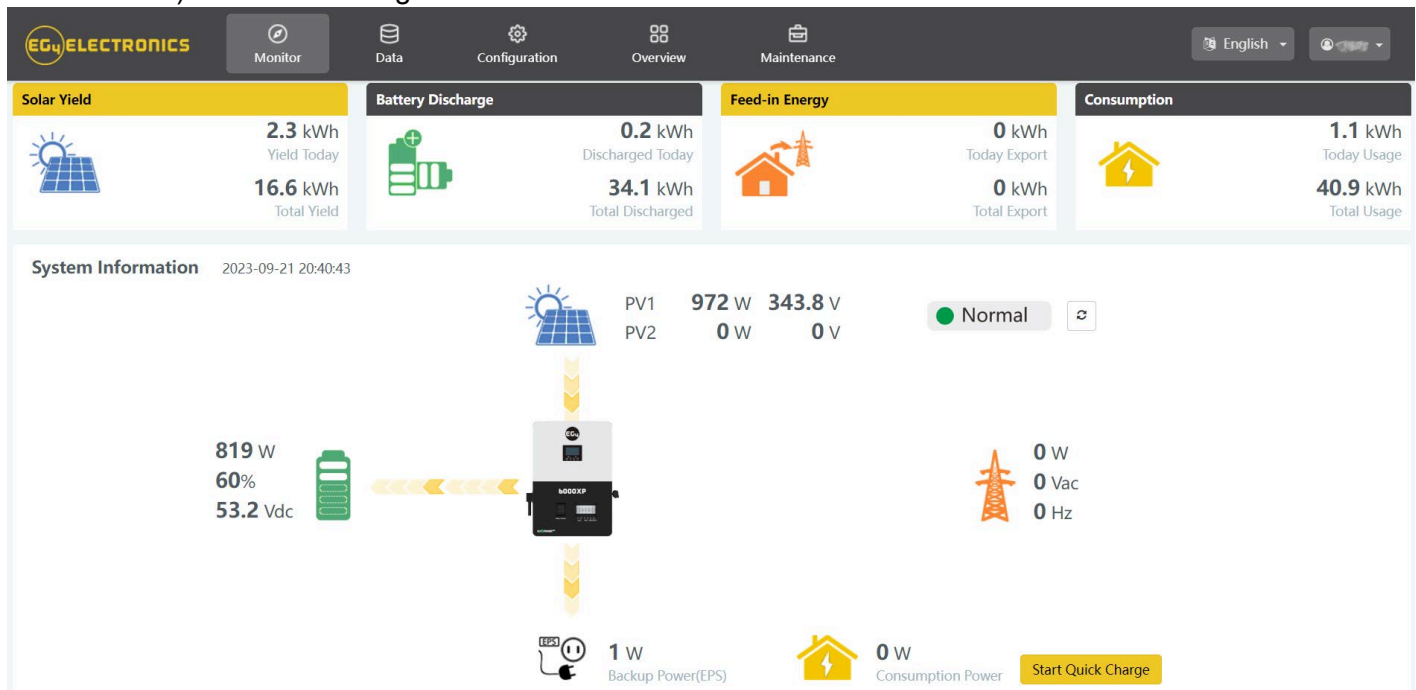

Name	Description
<b>Select station first</b>	Select which station to view, and then select which unit/dongle to view by choosing a serial number from the dropdown list. <b>Note:</b> Unchecking the box will only display serial numbers linked to the account.
<b>Solar Yield</b>	Shows power generated by the solar panels (for AC coupled inverters it shows the power generated by the on-grid inverter). The PV CT clamp will have to be installed to be able to show the data correctly. When the picture of the solar yielding is clicked, it will display how the solar energy has been used that day. A second click will show the totals since commissioning.
<b>Battery Discharge</b>	Shows the charge and discharge energy from the battery/batteries. When the battery picture is clicked, the display will switch between battery discharging and battery charging, showing totals for that day and since commissioning.
<b>Feed-in Energy</b>	Shows energy exported to grid for that day and since commissioning. When the picture is clicked, it shows energy imported from the grid for that day and since commissioning.
<b>Consumption</b>	Shows the total energy consumption of the property for that day and since commissioning.
<b>System information</b>	Displays power sources and energy flow, voltage, and amperage from lines to loads. Clicking the button beside the status will refresh the information to reflect real time data. <b>Note:</b> When the battery's color is yellow or red it means there is a warning or fault with the battery.
<b>GEN Quick Start</b>	Send a start signal to the generator.
<b>Start Quick Charge</b>	Clicking this will direct the inverter to charge batteries faster for <b>one hour</b> . It will then default back to its original setting.
<b>Language and User</b>	<b>English</b> – Clicking this will allow you to change the language of the page. <b>(Username)</b> – Clicking this will open a list with User Center (used for editing your profile), Modify password (used to change your password), and Logout (to logout of this account)

Input & Output Power and Energy Overview can also be viewed via the Monitoring Software.

*See following page for examples.*



Name	Description
<b>Input &amp; Output Power</b>	This chart shows the power curve for each day, including solar power, battery charge/discharge power and grid import/export power and consumption. Hovering over an item name will highlight it in the chart. Clicking it will remove it from the list.
<b>Energy Overview</b>	This chart shows energy production and consumption for each day, including solar production, battery, grid export and consumption. Hovering over an item name will highlight it in the chart. Clicking it will remove it from the list. Selecting 'Month' will show the energy statistics for each day. Selecting 'Year' will show energy for each month. Selecting 'Total' will show energy for each year.

## 7.3.2 DASHBOARD (DATA TAB)

The Data Tab displays additional detailed data including technical details for PV, battery, grid, and loads, that is helpful for analysis and maintenance.

Five categories make up the Data Tab view: "Chart", "Energy", "Data History", "Local data", and "Event History." For more details on each category, please see the following tables.

### Chart

Displays various parameters in chart format over a 24-hour period. There are separate charts for "PV Side", "Battery", "AC Side" and "Backup Output".

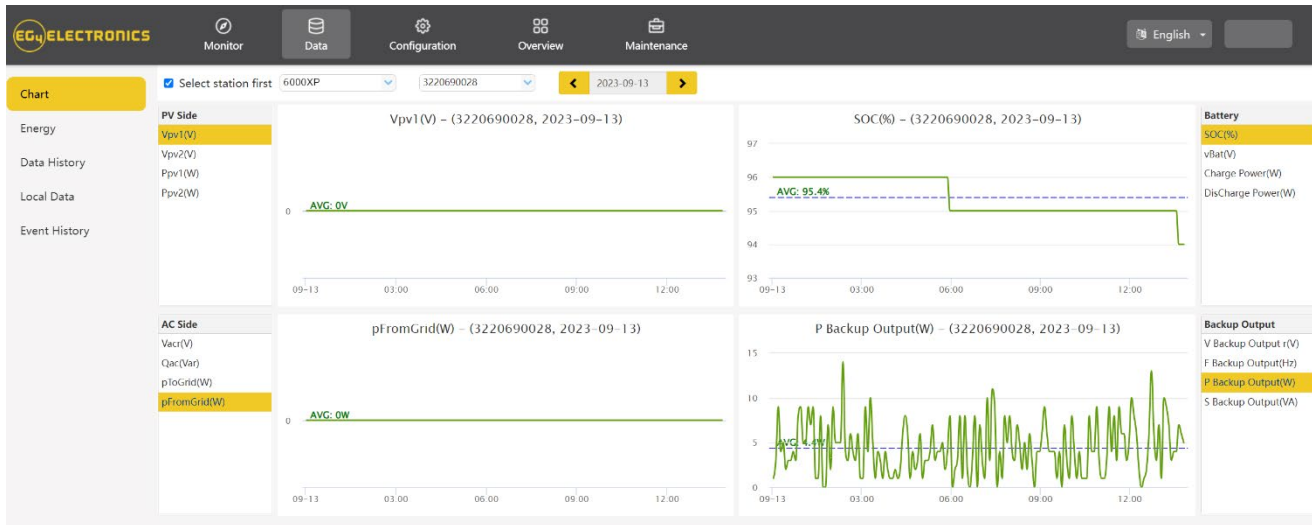

Name	Description
Vpv 1-2 (V)	Voltage of solar input
Ppv 1-2 (V)	Power of solar input
SOC (%)	Battery state of charge
vBat (V)	Battery voltage
Charge Power (W)	Battery charging power
Discharge Power (W)	Battery discharging power
Vacr (V)	Voltage of AC output
Qac (Var)	Reactive power of AC output
pToGrid (W)	Power feed into grid
pFromGrid (W)	Power feed from grid to inverter
V Backup Output r (V)	Load rated voltage
F Backup Output (Hz)	Load frequency
P Backup Output (W)	Load output power
S Backup Output (VA)	Load apparent power



## Energy

Displays how key energy parameters have varied over time.

- Selecting 'Month' will show the energy statistics for each day.
- Selecting 'Year' will show energy for each month.
- Selecting 'Total' will show energy for each year.

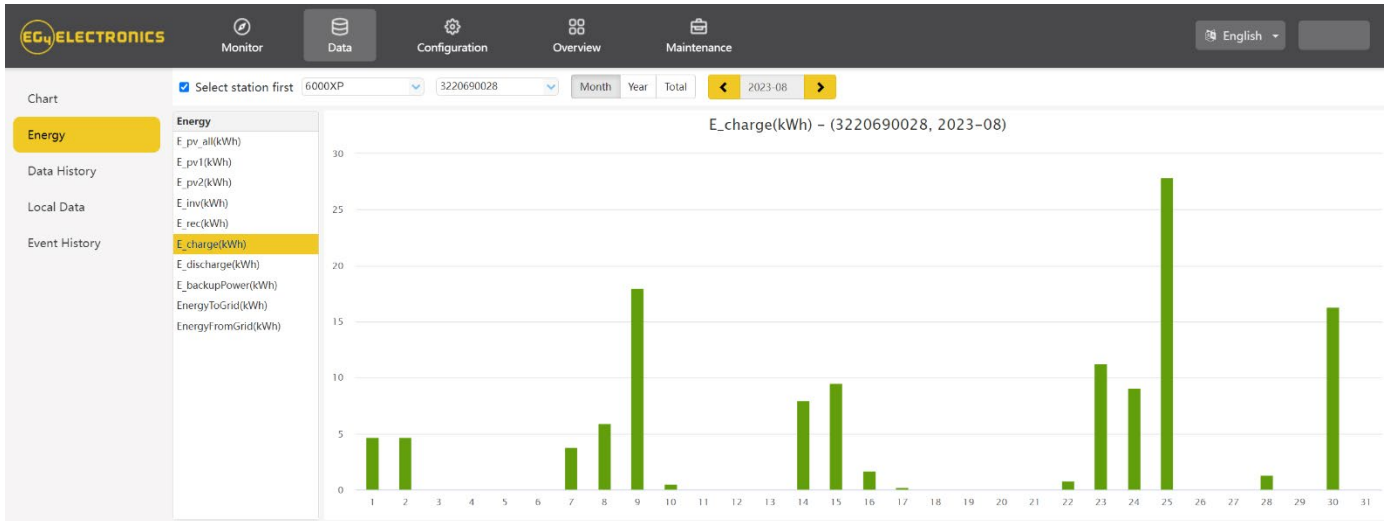

Name	Description
E_pv1(kWh)	Energy generated by PV string 1
E_pv2(kWh)	Energy generated by PV string 2
E_inv(kWh)	Energy output via AC output
E_rec(kWh)	Energy of AC charge
E_charge(kWh)	Energy used for battery charge
E_discharge(kWh)	Energy output by battery discharging
E_backupPower(kWh)	Load energy output
EnergyToGrid(kWh)	Feed-in energy
EnergyToUser(kWh)	Energy import from grid

## Data History

Displays the measured technical characteristics of PV, battery, load, and grid for users or their distributor's examination to promptly address any potential issues.

Advanced technical knowledge is necessary to properly comprehend this table. End users are advised to concentrate solely on the "Monitor" view, "Chart" and "Energy" sections as these only offer simple to comprehend performance data.



### Helpful Tip:

Data can be exported to an Excel file to provide your distributor for technical support. Distributors can then analyze the following factors in order to perform quick troubleshooting for their end users.

Serial number	Time	Status	Vpv1(V)	Vpv2(V)	vBat(V)	SOC(%)	Ppv1(W)	Ppv2(W)	pCharge	pDisCharge	Vacr(V)	Fac(Hz)	Pinv(W)	Prec(W)	PF	Vepsr(V)	Feps(Hz)	Peps(W)	pToGrid	pToUser	pLoad	ePv1De	ePv2De	eInDay	eB
1	3220690028	2023-09-13 13:49:03	0x40	0	0	53.1	94%	0	0	0	7	0	0	0	0	[0]	240	60.02	5	86	0	0	0	0	0
2	3220690028	2023-09-13 13:43:59	0x40	0	0	53.1	94%	0	0	0	6	0	0	0	0	[0]	240	59.99	6	80	0	0	0	0	0
3	3220690028	2023-09-13 13:38:58	0x40	0	0	53.1	94%	0	0	0	10	0	0	0	0	[0]	240.2	60.01	7	78	0	0	0	0	0
4	3220690028	2023-09-13 13:33:59	0x40	0	0	53.1	95%	0	0	0	5	0	0	0	0	[0]	239.9	59.98	4	78	0	0	0	0	0
5	3220690028	2023-09-13 13:28:58	0x40	0	0	53.1	95%	0	0	0	6	0	0	0	0	[0]	240	60.02	4	102	0	0	0	0	0
6	3220690028	2023-09-13 13:23:59	0x40	0	0	53.1	95%	0	0	0	4	0	0	0	0	[0]	240	60	3	84	0	0	0	0	0
7	3220690028	2023-09-13 13:18:57	0x40	0	0	53.1	95%	0	0	0	10	0	0	0	0	[0]	240.2	60	7	102	0	0	0	0	0
8	3220690028	2023-09-13 13:13:57	0x40	0	0	53.1	95%	0	0	0	13	0	0	0	0	[0]	240	60	9	72	0	0	0	0	0
9	3220690028	2023-09-13 13:08:56	0x40	0	0	53.1	95%	0	0	0	14	0	0	0	0	[0]	240.1	59.99	10	75	0	0	0	0	0
10	3220690028	2023-09-13 13:03:55	0x40	0	0	53.1	95%	0	0	0	2	0	0	0	0	[0]	240	60.01	1	94	0	0	0	0	0
11	3220690028	2023-09-13 12:58:52	0x40	0	0	53.1	95%	0	0	0	9	0	0	0	0	[0]	240	59.96	7	103	0	0	0	0	0
12	3220690028	2023-09-13 12:53:54	0x40	0	0	53.1	95%	0	0	0	4	0	0	0	0	[0]	240.1	60.02	3	84	0	0	0	0	0
13	3220690028	2023-09-13 12:48:51	0x40	0	0	53.1	95%	0	0	0	9	0	0	0	0	[0]	240.2	59.98	6	103	0	0	0	0	0
14	3220690028	2023-09-13 12:43:53	0x40	0	0	53.1	95%	0	0	0	14	0	0	0	0	[0]	240	59.98	13	103	0	0	0	0	0
15	3220690028	2023-09-13 12:38:50	0x40	0	0	53.1	95%	0	0	0	9	0	0	0	0	[0]	239.9	60.02	6	78	0	0	0	0	0
16	3220690028	2023-09-13 12:33:50	0x40	0	0	53.1	95%	0	0	0	2	0	0	0	0	[0]	240	59.98	2	86	0	0	0	0	0
17	3220690028	2023-09-13 12:28:49	0x40	0	0	53.1	95%	0	0	0	2	0	0	0	0	[0]	240	60	1	95	0	0	0	0	0
18	3220690028	2023-09-13 12:23:48	0x40	0	0	53.1	95%	0	0	0	1	0	0	0	0	[0]	240.1	60.02	0	91	0	0	0	0	0
19	3220690028	2023-09-13 12:18:47	0x40	0	0	53.1	95%	0	0	0	3	0	0	0	0	[0]	240	59.98	2	94	0	0	0	0	0
20	3220690028	2023-09-13 12:13:45	0x40	0	0	53.1	95%	0	0	0	8	0	0	0	0	[0]	240.1	59.99	6	106	0	0	0	0	0
21	3220690028	2023-09-13 12:08:46	0x40	0	0	53.1	95%	0	0	0	9	0	0	0	0	[0]	240	59.98	8	98	0	0	0	0	0
22	3220690028	2023-09-13 12:03:45	0x40	0	0	53.1	95%	0	0	0	11	0	0	0	0	[0]	240.1	60.02	10	105	0	0	0	0	0
23	3220690028	2023-09-13 11:58:45	0x40	0	0	53.1	95%	0	0	0	5	0	0	0	0	[0]	240.2	60.01	5	81	0	0	0	0	0
24	3220690028	2023-09-13 11:53:42	0x40	0	0	53.1	95%	0	0	0	4	0	0	0	0	[0]	239.9	59.98	3	88	0	0	0	0	0
25	3220690028	2023-09-13 11:48:42	0x40	0	0	53.1	95%	0	0	0	6	0	0	0	0	[0]	240.1	60.02	6	110	0	0	0	0	0

Name	Description
Vpv/Ppv	To check the MPPT
Vo/Po/So	To check the load type and if there is an overload when in load mode
Vb/SOC	To check the current state of charge and if the battery is overcharged or overly discharged.
Vac/Fac	To evaluate Grid performance and to check if working voltage and frequency range is adjusted to comply with grid
E-xxday	To evaluate energy distribution
E-xxall	To check if the system is working well under off grid mode

## Local Data

The data captured during the offline periods are displayed in the "Local data" section (loss of Internet or Wi-Fi). The only distinction from "Data History" is that it is used for offline data recording. Local data is recorded while the system is offline for more than 20 minutes and is taken every 5 minutes. Data can be stored in the system for a maximum of 90 days.

Serial number	Time	Status	Vpv1(V)	Vpv2(V)	vBat(V)	SOC(%)	Ppv1(W)	Ppv2(W)	pCharge	pDisCharge	Vacr(V)	Fac(Hz)	Pinv(W)	Prec(W)	PF	Vepsr(V)	Feps(Hz)	Peps(W)
[1, 90]																		

## Event History

The "Event History" section displays a timeline of events. (Notice and Fault events) If there is not a record of a "historical event," the inverter is properly connected and working without any issues.

Chart	<input checked="" type="checkbox"/> Select station first	6000XP	All Event	Export data		
Energy	Station	Serial number	Event Type	Event	Start Time	Time Recovered
Data History	1	6000XP	Notice	Battery voltage low	2023-09-11 12:51:43	2023-09-12 08:24:16
Local Data	2	6000XP	Notice	EPS Over load	2023-09-07 10:56:17	2023-09-07 11:06:20
Event History	3	6000XP	Notice	EPS Over load	2023-09-07 10:56:16	2023-09-07 11:06:14
	4	6000XP	Notice	Battery voltage low	2023-09-07 09:26:27	2023-09-07 09:46:26
	5	6000XP	Notice	Battery voltage low	2023-09-07 09:24:14	2023-09-07 09:44:19
	6	6000XP	Notice	EPS Over load	2023-09-07 08:06:43	2023-09-07 09:01:34
	7	6000XP	Notice	EPS Over load	2023-09-07 08:04:01	2023-09-07 08:59:12
	8	6000XP	Notice	EPS Over load	2023-09-06 16:28:16	2023-09-06 16:43:15
	9	6000XP	Notice	EPS Over load	2023-09-06 15:33:28	2023-09-06 16:23:18
	10	6000XP	Notice	EPS Over load	2023-09-06 15:33:27	2023-09-06 16:43:39
	11	6000XP	Notice	Battery voltage low	2023-09-06 09:13:52	2023-09-06 10:48:34
	12	6000XP	Notice	Battery voltage low	2023-09-06 09:09:32	2023-09-06 10:44:45
	13	6000XP	Notice	Communication failure with battery	2023-09-05 10:08:53	2023-09-05 10:11:41
	14	6000XP	Notice	Communication failure with battery	2023-09-05 09:58:16	2023-09-05 10:03:51
	15	6000XP	Fault	Internal CT offset out of range	2023-09-05 09:51:42	2023-09-05 12:12:13
	16	6000XP	Notice	Communication failure with battery	2023-09-05 09:32:20	2023-09-05 09:52:26
	17	6000XP	Notice	Communication failure with battery	2023-09-05 09:23:40	2023-09-05 09:27:20
	18	6000XP	Fault	Internal communication fault 1	2023-09-05 09:15:59	2023-09-05 09:51:42
	19	6000XP	Fault	Internal CT offset out of range	2023-09-05 09:13:28	2023-09-05 12:12:12
	20	6000XP	Notice	Battery voltage low	2023-09-01 11:54:55	2023-09-01 13:59:36
	21	6000XP	Notice	Battery voltage low	2023-09-01 11:54:40	2023-09-01 14:00:00
	22	6000XP	Notice	Battery voltage low	2023-09-01 10:14:27	2023-09-01 10:19:26

## 7.3.3 DASHBOARD (CONFIGURATION TAB)

The "Configuration" page is used for users to manage their station, dataloggers and user information.

### Stations

The Stations section will show all stations linked to your account. Clicking on a station name will display all inverters under that station or location.

Clicking the Add Station button creates another site if you have more than one station under the same account. This is useful for distributors who have multiple customers that would like assistance with monitoring/troubleshooting their inverters.

EG <sub>y</sub> ELECTRONICS						
Monitor	Data	Configuration	Overview	Maintenance	English	
Stations	+ Add Station					
	Search by station name					
Dongles	Station name	Country	Timezone	Daylight saving time	Create date	Action
Devices	1 6000XP	United States of America	GMT -5	No	2023 07 24	Station Management
Users						

## Dongles

Users can add the datalogger Serial Number (SN) in the station if they have more than one inverter in the station. The inverter will be shown on the system immediately when powered on after adding the datalogger and configuring the proper password for the Wi-Fi datalogger. Dongles can also be searched by individual serial number.

### ! Important

Before configuring the password for the Wi-Fi datalogger, please add the datalogger to the monitor system.

Serial number	Dongle type	Station name	Firmware	Create date	Connect Status	Action
1 BA3	Wi-Fi	6K		2023-07-24	Lost	Management
2 BA3	Wi-Fi	6K		2023-07-24	Lost	Management
3 BA3	Wi-Fi	6K		2023-07-24	Lost	Management
4 BA3	Wi-Fi	6K		2023-07-24	Lost	Management
5 BA3	Wi-Fi	6K		2023-07-24	Lost	Management

## Devices

Users can see the entire inverter list connected to the account and check if the inverter is online. Data can be exported to an Excel file for record keeping or to view specific inverter stats.

Serial number	Dongle	Station name	Phase	Device type	Power Rating	Model	Firmware	Status	Connect Status	BattParallelNum	BattCapacity	Action
1 3220690028	BA3	6K	1	Eco-Hybrid	6KW	66241	cCaa-135A5B	64	Lost	0	600	Management
2 3220690036	BA3	6K	1	Eco-Hybrid	6KW	66241	cCaa-135A5B	64	Lost	6	600	Management

## Users

This tab shows a full list of users, distributors and any other roles linked to the account.

End users can edit password and personal information in the user page. Distributors can add an installer account and end user account on this page.

### 7.3.4 DASHBOARD (OVERVIEW TAB)

"Overview" allows EG4 or its distributors to quickly monitor system-wide data for their end users, such as solar yields, battery discharging, and other factors.

## Station Overview

All the stations linked to the account can be found here. Clicking a station name will switch the main page to show the real time data.

Name	Status	SolarPower	ChargePower	DischargePower	Load	Solar Yield	BatteryDischarging	FeedEnergy	ConsumptionEnergy
1 6K	Offline	0 W	0 W	0 W	0 W	62.3 kWh	275.2 kWh	0 kWh	85.2 kWh

## Device Overview

All the inverters linked to the account can be found here. Clicking a serial number will switch the main page to show the real time data for that inverter.

Serial number	Status	SolarPower	ChargePower	DischargePower	Load	Solar Yield	Battery/Discharging	FeedEnergy	ConsumptionEnergy	Station name	Parallel	Action
1	Offline	0 W	0 W	0 W	0 W	46.3 kWh	153.3 kWh	0 kWh	57.4 kWh	6K		
2	Offline	0 W	0 W	0 W	0 W	16 kWh	121.9 kWh	0 kWh	27.8 kWh	6K		

### 7.3.5 DASHBOARD (MAINTENANCE TAB)

The "Maintenance" view is used for firmware updates and to remotely change settings on your inverter by selecting a station and then an inverter serial number.

Distributors can manage all settings for all inverters at once with the help of the batch setting capability supported by EG4's monitor system.

**Note:** *If trying to update firmware locally, see Section 8.*

#### **!** Important

Advanced technical knowledge is necessary to properly make changes. End users will only be able to see the "Remote Set" tab to make changes to their inverter.

## Remote Set

Setting Category
Application Setting
Charge Setting
Generator Charge
Discharge Setting

## 8. FIRMWARE UPDATES

### 8.1 FIRMWARE UPDATE VIA EG4 ELECTRONICS APP

**NOTE:** When updating your firmware through the EG4 APP, be sure to have plenty of battery life on your device and do not close the application. Make sure you have the Wi-Fi dongle connected securely and correctly configured for the inverter before performing the following steps.

**Step 1:** Open the EG4 Electronics APP on your mobile phone and select the “DOWNLOAD FIRMWARE” button.

**Step 2:** Choose the correct firmware file (contact your distributor for most up to date files) and select “DOWNLOAD” on the right side to download the file to your mobile device.

**Step 3:** Keep the APP running and go to your phone’s Wi-Fi settings. Connect your mobile device to the Dongle’s network. The Dongle’s Network ID will be the same as the Dongle’s Serial Number.

**Step 4:** Return to the home screen of the APP and select “LOCAL CONNECT”. Select the “Set” button on the bottom right side and proceed to the next step.

**Step 5:** After completing step 4, the Local Set Interface as shown above will appear. Swipe upward on your phone screen until the “Update Firmware” button is visible at the bottom of the APP’s display.

**Step 6:** Choose the correct installation package in the dropdown box and click “UPDATE FIRMWARE” to begin the updating process.

After clicking the, “UPDATE FIRMWARE” button, the update will begin. Update progress can be viewed via the APP as well as the inverter’s LCD screen. Once the update is completed, a notification will appear confirming that the firmware has been successfully updated (as shown in photo). After successfully updating firmware, the inverter will restart itself.

Make sure to update all inverters installed in the same ESS to the latest firmware.

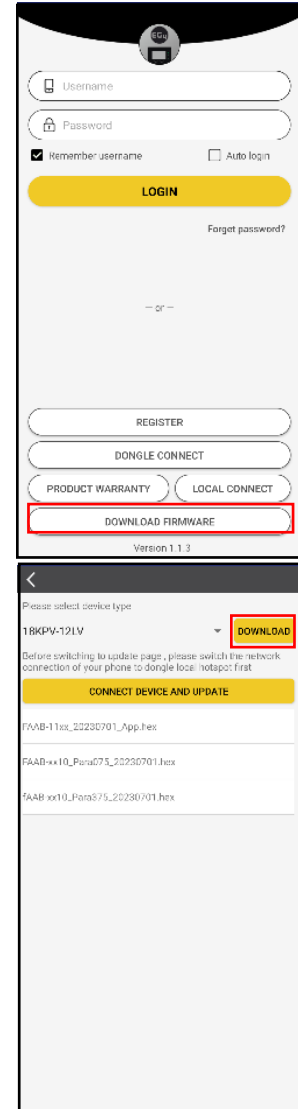

## 8.2 FIRMWARE UPDATE VIA MONITOR CENTER (WEBSITE)

**Step 1:** Distributors and installers can update the firmware for their inverters by using the EG4 Electronics website monitoring system. Please contact EG4 to make sure you have the correct files.

The screenshot shows the EG4 Electronics Monitor System interface. The top navigation bar includes Monitor, Data, Configuration, Overview, and Maintenance (highlighted with a red box). Below the navigation bar, there are search filters for Station (Serial number), Online Device, and Auto Reload. The Firmware File section includes buttons for Choose file, Upload File, and Upload BMS File. The main content area displays a table of inverter data with columns for Serial number, Dongle, FW Code, Connect Statu, and Action. The 'Remote Update' button in the left sidebar is highlighted with a red box.

Serial number	Dongle	FW Code	Connect Statu	Action
1	1234567890	XX12345678	? XXXX-XXXX	Connected
2			?	
3			?	
4			?	
5			?	
6			?	
7			?	
8			?	
9			?	

**Step 2:** Log into the EG4 Electronics Monitor System. Select “Maintenance,” and then select “Remote Update.”

The screenshot shows the EG4 Electronics Monitor System interface. The top navigation bar includes Monitor, Data, Configuration, Overview, and Maintenance. Below the navigation bar, there are search filters for Station (Serial number), Online Device, and Auto Reload. The Firmware File section includes buttons for Choose file, Upload File, and Upload BMS File. The main content area displays a table of inverter data with columns for Serial number, Dongle, FW Code, Connect Statu, and Action. The 'Standard Update' button in the 'Action' column for the first row is highlighted with a red box.

Serial number	Dongle	FW Code	Connect Statu	Action
1	1234567890	XX12345678	? XXXX-XXXX	Connected
2			?	
3			?	
4			?	
5			?	
6			?	
7			?	
8			?	
9			?	

**Step 3:** Choose the inverter you would like to update and then select “Standard Update”. The Monitor Center will begin updating both firmware files in the inverter. The latest version of the firmware will be displayed in the bottom right window.

## 9. SMARTPHONE APP SETUP

You need to register for a monitoring account and set the Wi-Fi password for the Wi-Fi dongle **before** using EG4's monitoring system.

### 1. Register your account

Visit <https://monitor.eg4electronics.com/> or download the 'EG4 Monitor' app to register for an end-user account. Please contact [support@eg4electronics.com](mailto:support@eg4electronics.com) for distributor or installer accounts.

### 2. When registering the account, provide the following information:

- Customer code: This is the code for a distributor or installer. Please contact your distributor or installer to obtain this code.
- Dongle SN: The serial number is attached to the Wi-Fi/LAN shell.
- Dongle PIN: PIN is attached to the Wi-Fi/LAN shell below the SN.

### 3. Set your Wi-fi password

- Plug in the Wi-Fi dongle, and power on the inverter.
- Wait until any LED on the Wi-Fi module is flashing, and then connect your phone to the Wi-Fi hotspot. The hotspot name is the same as the Wi-Fi dongle serial number. (See image on left)
- Open the app. Click on "Wi-Fi MODULE CONNECT". Click the Yellow refresh button to display a list of available networks. Select your home wireless network name and enter your password.
- After clicking Home Wi-Fi Connect, the Wi-Fi dongle will reset. After you set the correct password, three lights will be solid ON, which means the inverter is connected to the server. You can then return to the login page and input your account and password to begin monitoring your system.

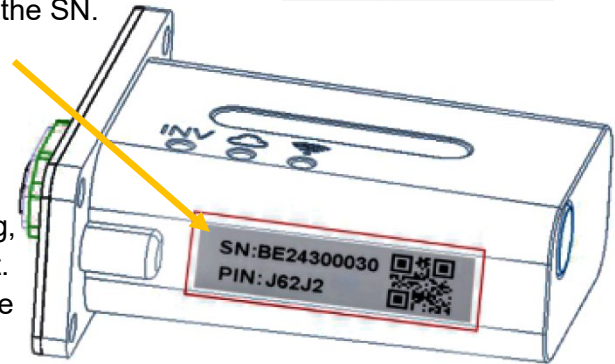
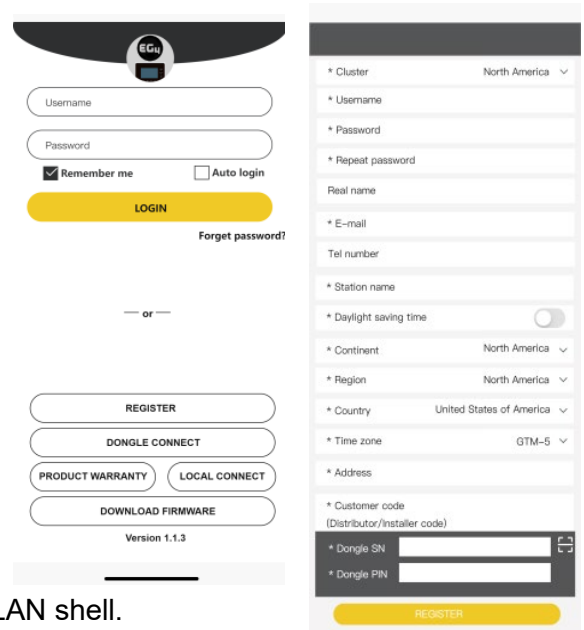
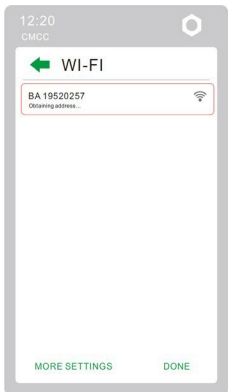



## Local Monitoring Setup with the EG4 Monitor App

If there is no Wi-Fi available at the location, you can use the Bluetooth function on your mobile device to monitor or set up the system.

1. Download the EG4 Monitor app.
2. Select "Local Connect." You can now monitor and set up the system via Bluetooth or TCP Connect.
3. Click "Local Connect." Select "Bluetooth Connect." On the next page, select the serial number of the unit that has the dongle connected.
4. Now you may view your system information through Bluetooth connection on your mobile device.

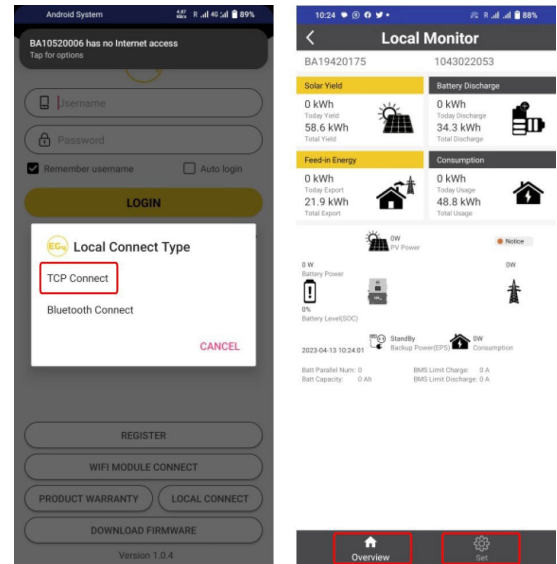

## 10. OPERATION GUIDE

### 10.1 AC CHARGE MODE

In this mode, users can charge batteries with grid power when electricity prices are low, then use battery power to power loads.

#### Application Scenario



When users have a Time of Use (TOU) rate plan.

AC Charge

AC Charge (?)	Disable	Set	AC Charge Battery Current(A) (?)	[0, 100]	Set
AC Charge Start Time 1	[0, 23] : [0, 59]	Set	AC Charge Start Time 2	[0, 23] : [0, 59]	Set
AC Charge End Time 1	[0, 23] : [0, 59]	Set	AC Charge End Time 2	[0, 23] : [0, 59]	Set
AC Charge Start Battery Voltage(V) (?)	[38.4, 52]	Set	AC Charge End Battery Voltage(V) (?)	[48, 59]	Set
AC Charge Start Battery SOC(%) (?)	[0, 90]	Set	AC Charge End Battery SOC(%) (?)	[20, 100]	Set

### Working Modes

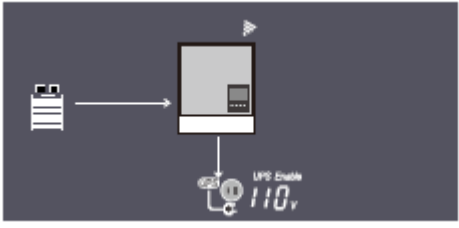
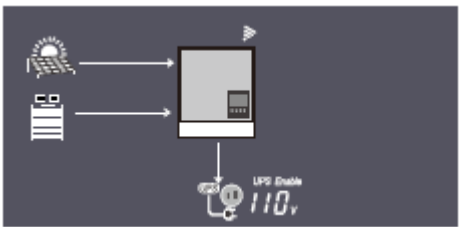
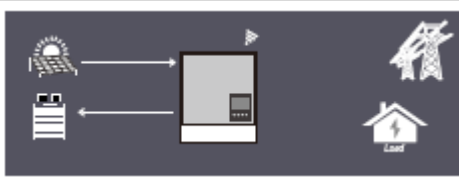
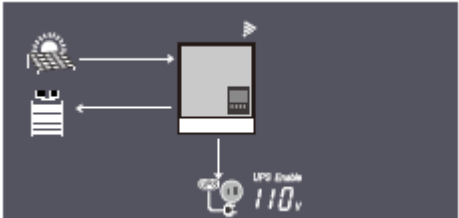
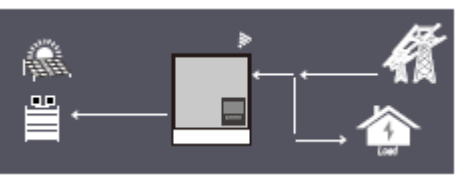
Mode	Diagram	Comments
Bypass Mode		AC powers the load
PV Charge Bypass		PV charges the battery while AC powers the load

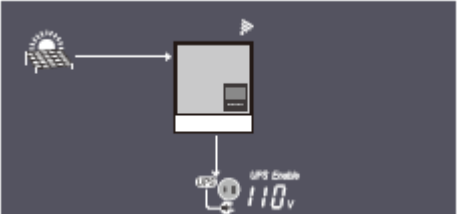
<p><b>BAT Off-Grid</b></p>		<p>Battery powers the load</p>
<p><b>PV+BAT Off-Grid</b></p>		<p>PV &amp; Battery power the load</p>
<p><b>PV Charge</b></p>		<ol style="list-style-type: none"> <li>1. With EPS output switch off, the inverter charges the battery only</li> <li>2. With battery power off, PV can wake up the battery automatically</li> </ol>
<p><b>PV Charge+Off-Grid</b></p>		<p>PV charges the battery and powers the load</p>
<p><b>AC Charge</b></p>		<ol style="list-style-type: none"> <li>1. AC powers the battery from AC Input (Grid) or Generator Input (GEN)</li> <li>2. When batteries reach low threshold, charge bank with Grid/GEN</li> </ol>
<p><b>PV+AC Charge</b></p>		<p>PV &amp; AC charge the battery. AC is from AC Input (Grid) or Generator Input (GEN)</p>
<p><b>PV Off-Grid</b></p>		<p>PV powers the load. NOTE: Load power depends on PV energy input and may be unstable</p>

## 10.2 RAPID SHUTDOWN (RSD)

The inverter includes a rapid shutdown system that complies with 2017 and 2020 NEC 690.12 requirements. A rapid shutdown switch should be connected to the RSD terminals on the master inverter and mounted on a readily accessible location outdoors (check with your AHJ for specific requirements). For paralleled systems, the RSD needs only to connect to the master inverter. When the switch is engaged, it will shut down all inverters in parallel past the master.

**Note:** When using supported EG4 batteries in closed-loop communications with the inverter, the RSD also initiates ESS Disconnect as required by NEC code

The system can utilize an External E-Stop Switch if your AHJ deems it necessary. When doing so, setting 28 must be set to Enable to engage the function.

Type of External E-Stop Switch for RSD Requirements:

The external switch must have normally closed contact type for emergency shutdown.

### 10.2.1 EXTERNAL RSD WIRING INSTRUCTIONS

The image below showcases an example diagram using a Tigo RSD Transmitter (not included). Wire the E-Stop Switch into the RSD terminals on the master inverter as shown below, following the switch's specifications. Please refer to the switch's manual for exact specifications and wiring instructions.

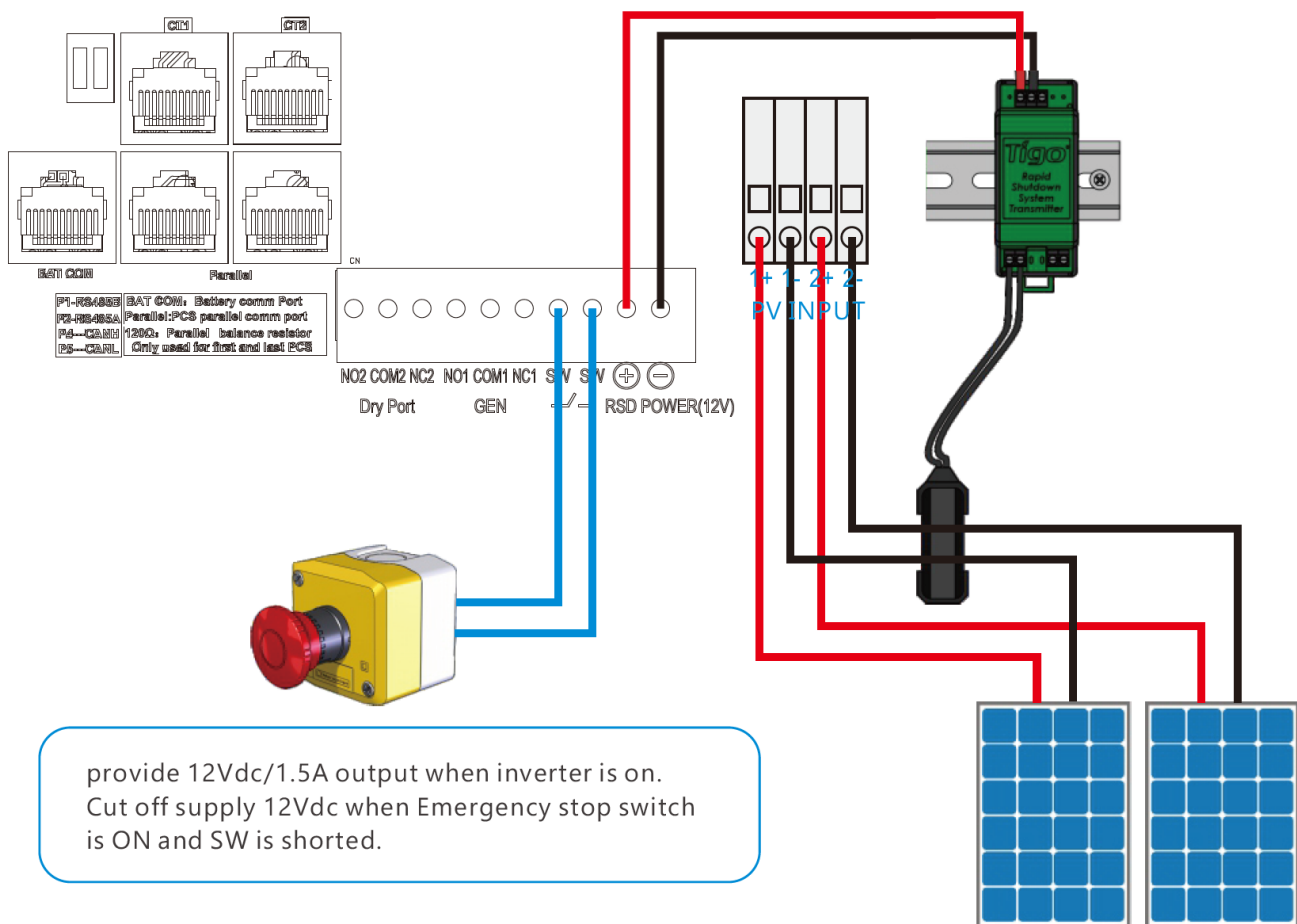

## 10.3 LCD DISPLAY AND SETTINGS

The user can wake up the LCD screen by simply pressing the Enter button. System status, real-time power, and daily and accumulated energy information can all be conveniently viewed on the inverter's LCD screen. Additionally, users can also check the alarm and fault record on the display for troubleshooting.

LED Indicator		Messages	
1 (Normal)	Green	Solid ON	Working normal
		Flashing	Fast: Warning Slow: Firmware Update
2 (Fault)	Red	Flashing	Fault detected in the inverter

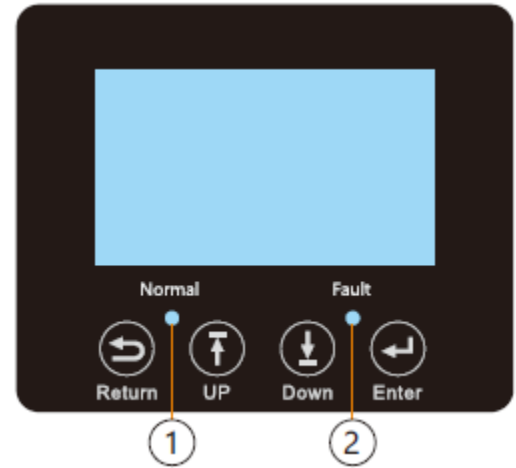

## 10.3.1 LCD DISPLAY

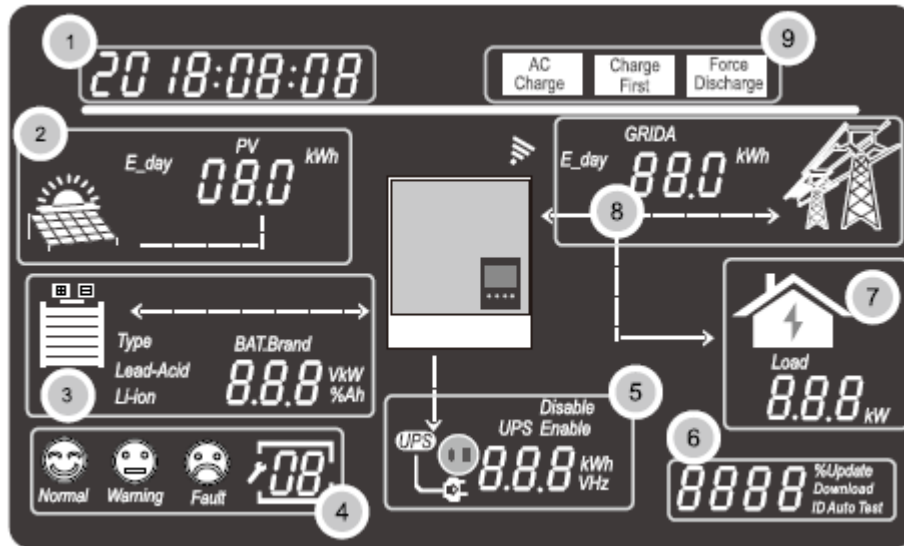

The data on the LCD screen updates every 3 seconds as various information is displayed in each section. See table on next page for more details.

No.	Description	Comments
1	General Information Display Area	Displays the current system status by default. Pressing the Up/Down buttons will cycle through Time, Date, Single/Parallel Inverter Setting, Inverter Serial Number, and Firmware Version. When entering new settings, the selection information is displayed in this area.
2	Photo Voltaic (PV) Data	Cycles every 3 seconds through: PV1 Voltage, PV2 Voltage, PV1 power, PV2 Power, PV1 Energy (day), PV2 Energy (day), PV1 Energy (total to-date), and PV2 Energy (total to-date).
3	Battery information and data	Displays the battery type and brand. For lead-acid batteries, this area will cycle every 3 seconds through the CV voltage, Float Charge Voltage, Cut-off Voltage, and Discharge End Voltage. For Lithium-ion batteries, this area will cycle every 3 seconds through the Voltage (V), SOC (%), Power (kW), and Capacity (Ah).
4	System Status and Codes	There are three system status icons, Normal, Warning and Fault, and a 2-digit field that displays codes. <ul style="list-style-type: none"> <li>• Status = 'Normal': nothing is displayed in the 2-digit field</li> <li>• Status = 'Warning': warning code is displayed in the 2-digit field.</li> <li>• Status = 'Fault': fault code is displayed in the 2-digit field.</li> <li>• System in 'Setting' mode: current Setting is displayed in the 2-digit field.</li> </ul>
5	UPS/EPS output information and data	When the UPS function is enabled, this area will cycle every 3 seconds through UPS1 V, UPS1 Hz, UPS1 kW, UPS2 V, and UPS2 kW. There is no UPS2 Hz, because it will always be the same as UPS1 frequency by default. UPS1=Phase1=L1, UPS2=Phase2=L2.
6	Programming & the percentage of AC output power	When in Off-Grid mode, this area will display the percentage of the maximum AC output power. Relevant information is displayed during firmware updates
7	Load consumption	Displays the power consumption by the load in the On-grid Mode.
8	Grid and Generator information	Cycles every 3 seconds through: Grid1 Voltage, Grid2 Voltage, Grid Hz, Gen1 Voltage, Gen2 Voltage, Gen Hz, Grid Power, Grid Energy (day), and Grid Energy (total to-date). Grid1=Phase1=L1, Grid2=Phase2=L2; Gen1=Phase1=L1, Gen2=Phase2=L2
9	Working mode area	When the user makes changes to the 6000XP inverter through the LCD, this area will display the AC Charge, Charge First and Force Discharge settings. Otherwise, this area displays nothing.

## Inverter Status Displays

### Normal/Running Status:

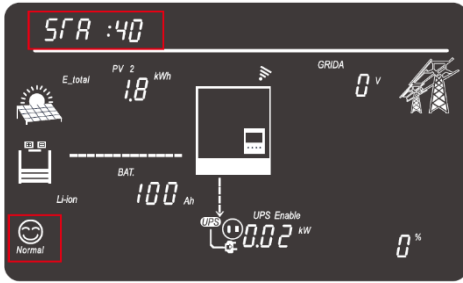

### Warning Status:

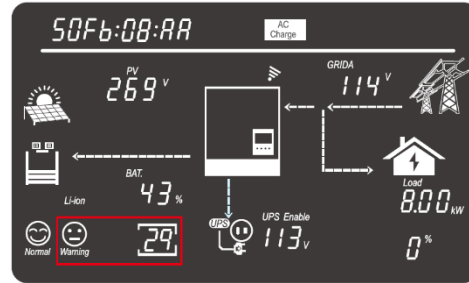

### Fault Status:

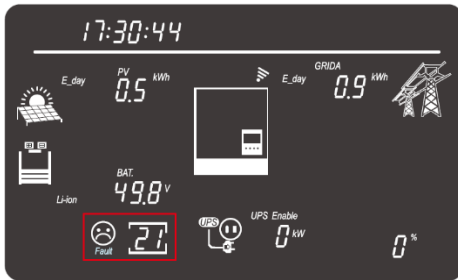

### Flash Status:

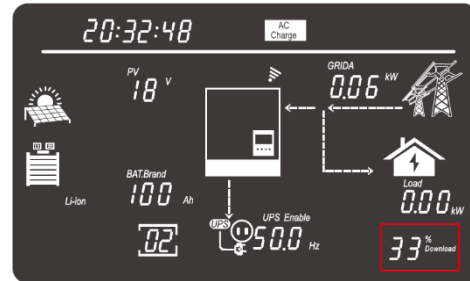

### Grid Status for GRID A (Utility):

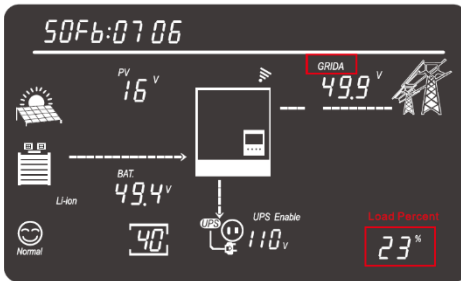

**NOTE:** When GRID A is displayed, AC utility information is displayed. Percent at bottom right is % load (e.g. 23%).

### Grid Status for GRID B (Generator):

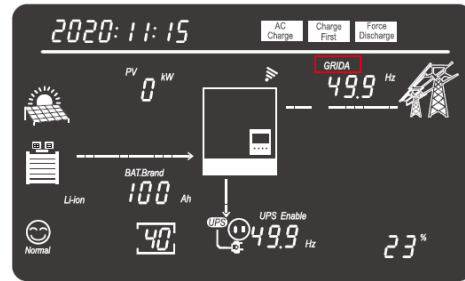

**NOTE:** When GRID B is displayed, Generator information is displayed. Percent at bottom right is % load (e.g. 23%).

## 11. LCD SETTINGS

There are four (4) buttons on the LCD screen used to select various modes and make changes to settings:

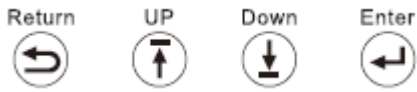

**Step 1:** Press the Enter button for ≈3 seconds to enter the **setting mode**. The data in the 'General Information Display Area' will flash and the 2-digit Setting field will be displayed.

**Step 2:** Press Up/Down to cycle through the setting settings (1-29).



**Step 3:** Press Enter to confirm the desired setting.

**Step 4:** Press Up/Down to cycle through the settings.

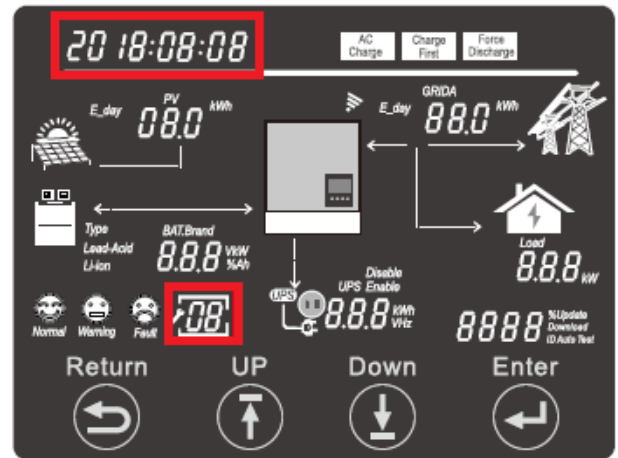
**Step 5:** Press Enter to confirm the desired setting.

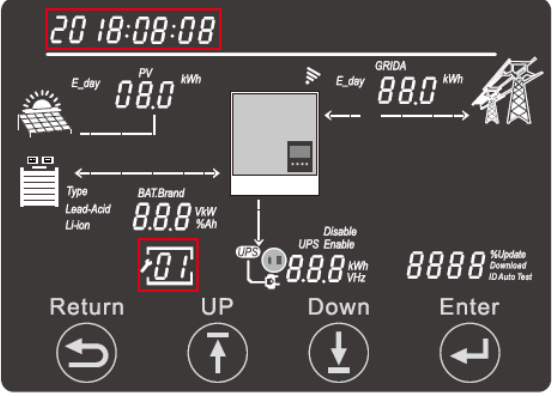
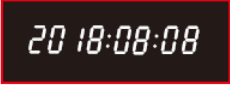
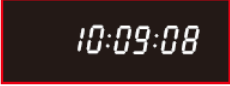
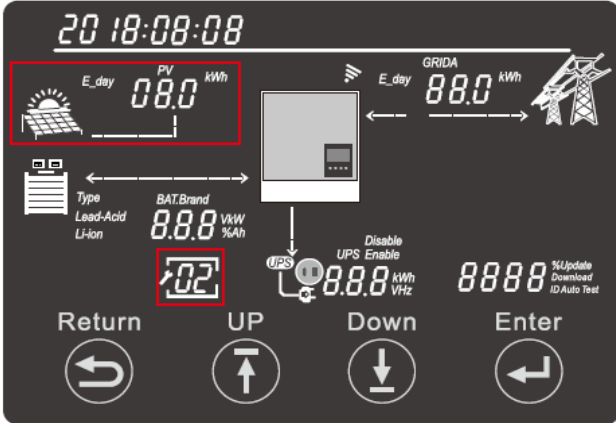

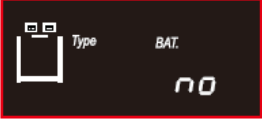
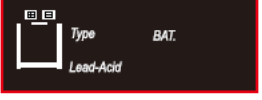
#	Description	Setting Option(s)
1	Date & Time	 <p>Setting Year/Month/day</p>  <p>Setting hour/minute/second</p>  <p>This setting allows the user to set the Local Date and Time.</p>
2	PV Input Mode	 <p>This setting allows the user to set the PV Input Mode.</p> <p><b>PV Input Type:</b>  <b>S</b>=two independent strings,  <b>P</b>=same string input for 2 MPPTs  <i>Default: S</i></p>

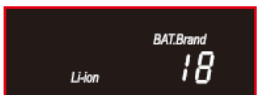
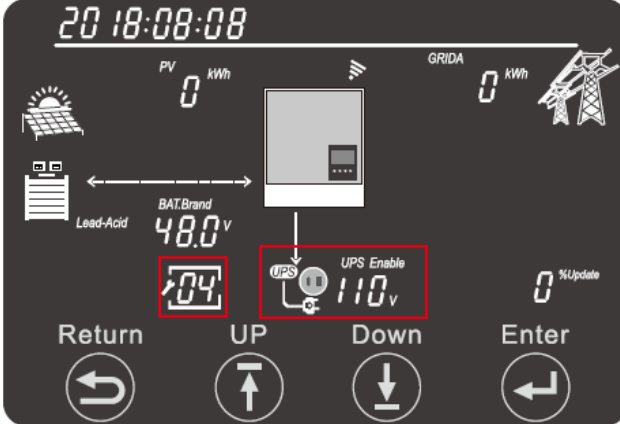
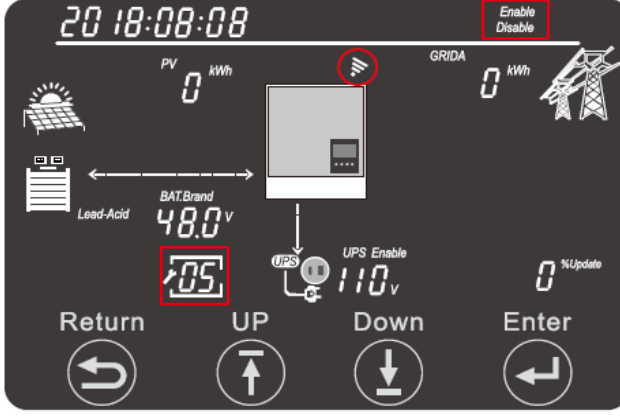
<p><b>3</b></p>	<p>Battery</p>	<p>This setting allows the user to identify if Batteries will be used in the system and, if yes, the type of batteries (Lead-Acid or Lithium-Ion).          Operate with <b>No Battery</b>  <b>Step 1:</b> Choose battery type first. When “no” begins flashing, select Enter to operate with No Battery  <b>Note: It is NOT recommended to operate without batteries</b></p> <p>Operate with Lead-Acid Battery  <b>Step 1:</b> Choose battery type first. When “Lead-Acid” begins flashing, select Enter to operate with Lead-Acid Batteries.  <b>Step 2:</b> Enter the Battery Capacity (Ah)</p> <p>Operate with Lithium Battery  <b>Step 1:</b> Choose battery type first. When “Li-ion” begins flashing, select Enter to operate with Lithium Batteries.  <b>Step 2:</b> Enter the Battery Brand (e.g., 0=EG4, 2=Pylon, 6=LuxPower, 8=Dyness)</p>	    
<p><b>4</b></p>	<p>UPS Output Voltage and Frequency</p>		<p>This setting allows the user to set the inverter output voltage and frequency.</p> <p><b>AC Output Voltage:</b>          200VAC, 208VAC, 220VAC, 230VAC, 240VAC  <i>Default: 240VAC</i></p> <p><b>AC Output Frequency:</b>          50Hz, 60Hz  <i>Default: 60Hz</i></p>
<p><b>5</b></p>	<p>Buzzer Enable</p>		<p>This setting allows the user to enable or disable the inverter buzzer.</p> <p><b>Inverter Buzzer:</b>          Enable/Disable  <i>Default: Enable</i></p>



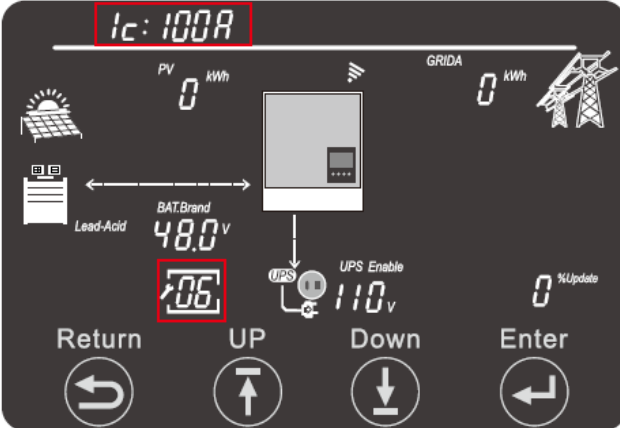
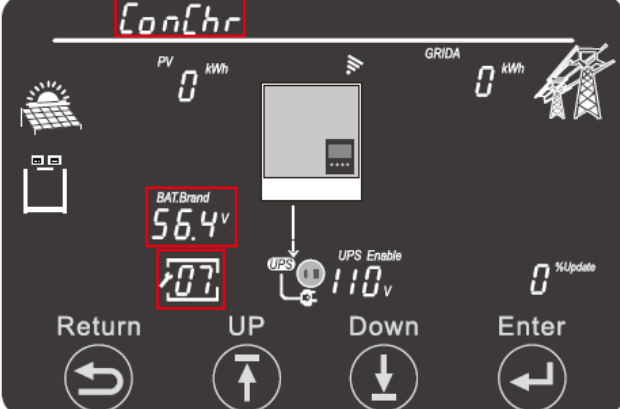
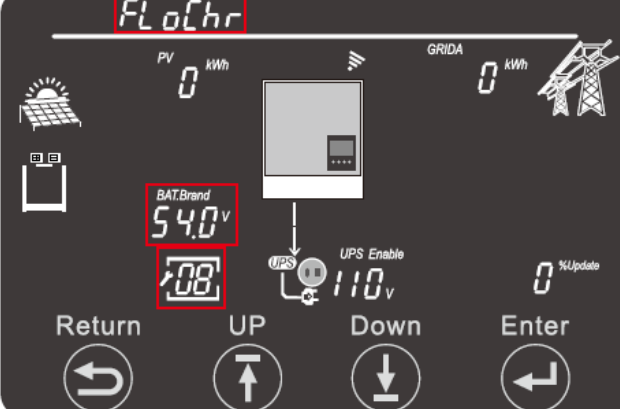
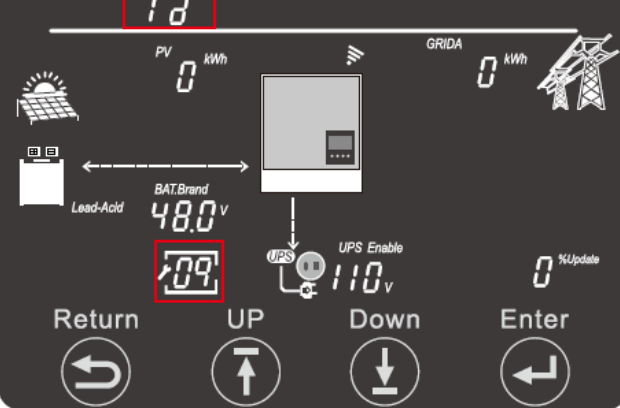





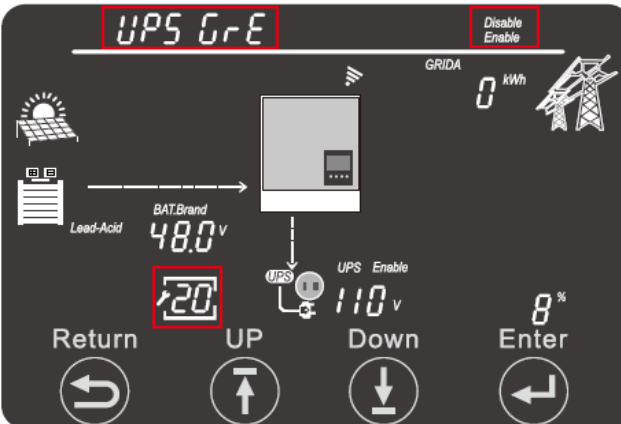
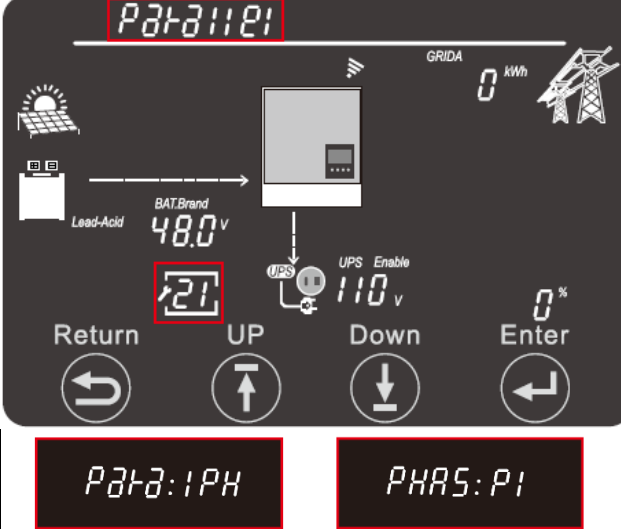
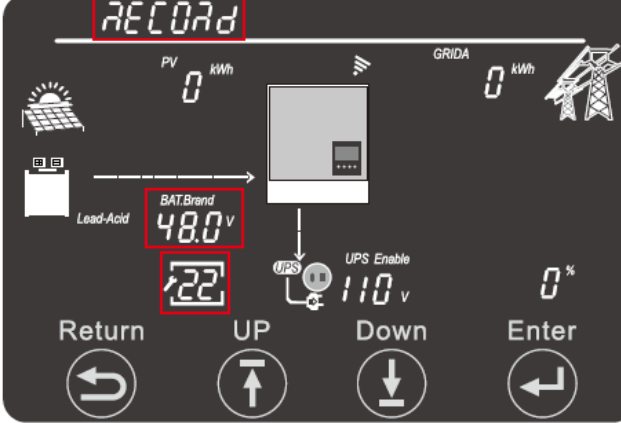

<p>6</p>	<p>lc: Maximum Charge Current (Utility+Solar)</p>		<p>This setting allows the user to set the maximum charge current.</p> <p><b>Total Charge Current:</b> Range: 0 – 125A Default: 125A</p> <p><b>AC Charge Current:</b> Range: 0 – 125A Default: 30A</p> <p><b>Generator Charge Current:</b> Range: 0 – 110A Default: 30A</p>
<p>7</p>	<p>ConChr: CV Voltage (Lead-Acid Only)</p>		<p>This setting allows the user to set the Charging Voltage for Lead-Acid batteries only.</p> <p><b>Lead-Acid Charging Voltage:</b> Range: 50.0 – 59.0VDC Default: 56.4VDC</p>
<p>8</p>	<p>FloChr: Floating Charge Voltage (Lead-Acid Only)</p>		<p>This setting allows the user to set the Lead-Acid Battery Float Charge Voltage.</p> <p><b>Lead-Acid Floating Charge Voltage:</b> Range: 50.0 – 56.0VDC Default: 54.0VDC</p>
<p>9</p>	<p>ld: Maximum Discharge Current</p>		<p>This setting allows the user to set the Maximum Discharge Current.</p> <p><b>Maximum Discharge Current:</b> Range: 10 – 140A Default: 140A</p>

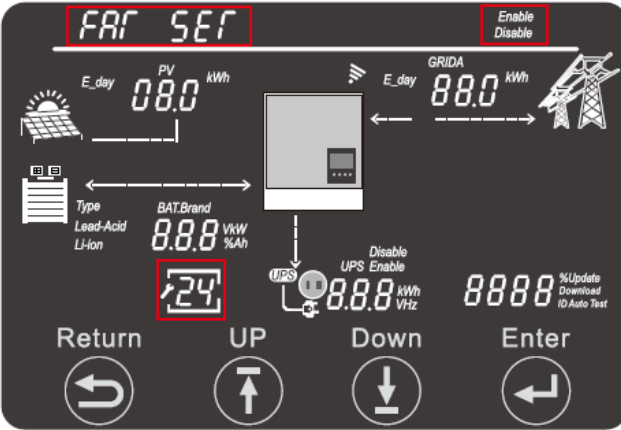
<p><b>10</b></p>	<p>TEOd: Discharge Control Type (Volt/SOC)</p>		<p>This setting allows the user to select Voltage or SOC as the trigger for battery discharge.</p> <div style="border: 1px solid black; padding: 5px; margin: 5px 0;">TEOd:V0L</div> <div style="border: 1px solid black; padding: 5px; margin: 5px 0;">TEOd:SOE</div>
<p><b>11</b></p>	<p>CutOFF: Cut off Voltage/SOC</p>		<p>This setting allows the user to set the cutoff Voltage or SOC based on the selection made in Setting 10, TEOd.</p> <p><b>Cutoff Voltage:</b> 40.0 – On-Grid EOD Voltage <i>Default: 42V</i></p> <p><b>Cutoff SOC:</b> <b>Range:</b> 0 – On-Grid EOD SOC% <i>Default: 15%</i></p>
<p><b>12</b></p>	<p>Eod: Battery Discharge Cutoff</p>		<p>This setting allows the user to set the End-Of-Discharge Voltage and SOC parameters.</p> <p><b>End of Discharge Cutoff Voltage:</b> <b>Range:</b> Cutoff Voltage – 56V <i>Default: 42V</i></p> <p><b>End of Discharge Cutoff SOC:</b> <b>Range:</b> Cutoff SOC – 90% <i>Default: 15%</i></p>

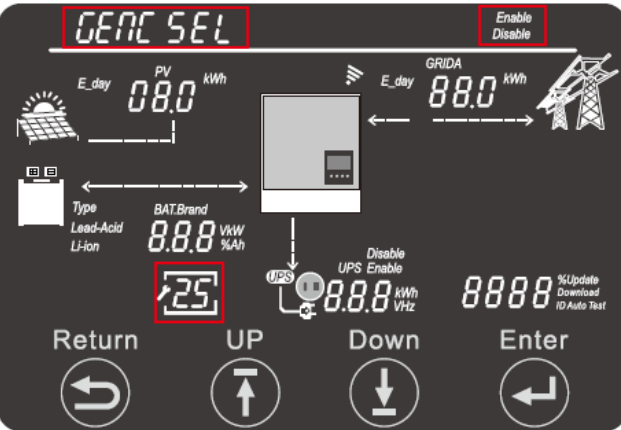
<p><b>13</b></p>	<p>AC In: AC Voltage Range Setting</p>		<p>This setting allows the user to set the AC Input Voltage Range</p> <p><b>AC In Voltage Range:</b> APL – 90-280VAC UPS – 170-280VAC</p> <p><b>Ac In: APL</b></p> <p><b>Ac In: UPS</b></p>
<p><b>14</b></p>	<p>AC Charge Setting</p>	<p>To configure AC charging, the user must first enable AC Charging, confirm the full battery SOC value, and set the confirmation time periods 1, 2, and 3.</p> <p><b>AcCh: d 15</b></p> <p><b>AcCh: U0L</b> <small>start AC Charge</small></p> <p><b>AcCh: P1:00:00</b> <small>start AC Charge</small></p> <p><b>AcCh: P1:23:59</b> <small>end AC Charge</small></p> <p><b>AcCh: P2:00:00</b> <small>start AC Charge</small></p> <p><b>AcCh: P3:00:00</b> <small>start AC Charge</small></p> <p><b>BAT. 15%</b></p> <p><b>AC Charge Control Settings for Voltage and SOC:</b></p> <p><b>Voltage:</b> Start Voltage: 35.4 – 52V End Voltage: 48 - 59V</p> <p><b>SOC:</b> Start SOC: 1 – 90% End SOC: 20 – 100%</p> <p><b>AC Charge Control Settings for Start/End Times:</b></p> <p><b>Start Time1-3:</b> <b>Range:</b> 00:00 – 23:59 <b>Default:</b> 00:00 – 00:00</p> <p><b>End Time1-3:</b> <b>Range:</b> 00:00 – 23:59 <b>Default:</b> 00:00 – 00:00</p>	

<p>15</p>	<p>AC Input Load Timer Settings</p>		<p>This setting allows the user to set the Start/End times for the Grid/Utility to supply power to the load.</p> <p><b>Start Time1-3:</b> 00:00 – 23:59  <b>Default:</b> 00:00 – 00:00  <b>End Time1-3:</b> 00:00 – 23:59  <b>Default:</b> 00:00 – 00:00</p>
<p>17</p>	<p>Battery Wakeup</p>		<p>This setting allows the user to enable or disable the battery wakeup feature. It is not applicable if no battery type is defined.</p> <p><b>Range:</b> Enable/Disable</p>
<p>18</p>	<p>Max Generator Input Power</p>		<p>This setting allows the user to set the maximum generator input power.</p> <p><b>Range:</b> 0-7369W  <b>Default:</b> 7369</p>
<p>19</p>	<p>PV Off-Grid Enable/Disable</p>		<p>This setting allows the user to configure the system to only use PV for loads. Due to voltage fluctuation, power output may be inconsistent.</p> <p><b>Range:</b> Enable/Disable  <b>Default:</b> Enable</p>

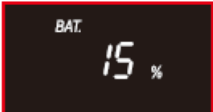
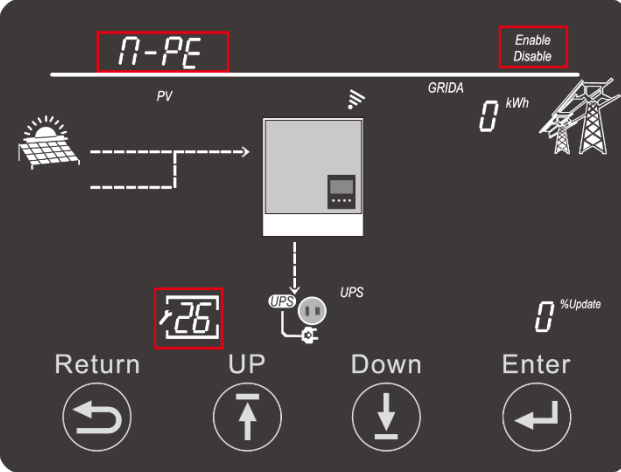
<p>20</p>	<p>Power Save Function</p>		<p>This setting allows the user to enable or disable the Power Save Functions, 'Green Function' and 'ECO Mode'.</p> <p><b>Range:</b> Enable/Disable</p> <p>The default settings for both functions are set to disabled.</p>
<p>21</p>	<p>Parallel Setting</p>	 <p><b>Parallel Type:</b> NoPL (Not Parallel), 1PH (Single Phase), 3PH (Three Phase)  <i>Default: NoPL</i></p> <p><b>Parallel Phase:</b> P1 (R-Phase), P2 (S-Phase), P3 (T-Phase)  <i>Default: P1 (R-Phase)</i></p> <p><b>Battery Share Enable/Disable:</b> Disable/Enable  <i>Default: Disable</i></p>	<p>This setting allows the user to select the inverter paralleling configuration.</p>
<p>22</p>	<p>Error/Alarm Record</p>	 <p><b>Error Record:</b>-&gt;Record Setting-&gt;Record Message          (Year:Month:Day; Hour:Min:Sec; Error Code)</p> <p><b>Alarm Record:</b>-&gt;Record Setting-&gt;Record Message          (Year:Month:Day; Hour:Min:Sec; Alarm Code)</p>	<p>This setting allows the user to see Error and Alarm records.</p>

<p>24</p>	<p>Fan Speed Setting</p>	 <p><b>Fan1/2 Slope: Enable/Disable</b>  <i>Default: Disable</i></p> <p><b>Range: 20 – 100%</b>  <i>Default: 70%</i></p>	<p>This setting allows the user to adjust the operation of the Inverter's two fans. The user can set the speed (20-100%) and enable or disable the slope (Enabling the slope allows the fans to ramp up/down to/from the fan speed setting).</p>  
<p>25</p>	<p>Generator Charge Setting</p>	 <p><b>Generator Charge Control Type: VOL or SOC</b>  <i>Default: VOL</i></p> <p><b>Generator Charge Control Value (Volts):</b>          Start Voltage: 38.4 – 52V, End Voltage: 48 – 59V</p> <p><b>Generator Charge Control Value (SOC):</b>  <b>Range: Start SOC: 1 – 90%, End SOC: 20 – 100%</b></p>	<p>This setting allows the user to select the Generator charge control parameter (Voltage or SOC) and the associated Start/End Voltage or SOC.</p>    
<p>26</p>	<p>Neutral-Ground Bonding Function</p>		<p>This setting allows the user to enable or disable the internal neutral-ground bond. The inverter must be in standby to make this change. Turn the "EPS Output" switch to off to engage standby mode.</p> <p><b>Range: Enable/Disable</b>  <i>Default: Enable</i></p>  

<p>27</p>	<p>PV Isolation Protection</p>	<p>The display shows 'PV-ISO' at the top. Below it is a diagram of the inverter system with PV panels, a central inverter, and a UPS. The 'Enable/Disable' menu is highlighted in red. Navigation buttons at the bottom are labeled 'Return', 'UP', 'Down', and 'Enter'.</p>	<p>This setting allows the user to enable or disable the PV Isolation Protection of the MPPT.</p> <p><b>Range:</b> Enable/Disable <b>Default:</b> Enable</p> <p><b>Enable</b></p> <p><b>Disable</b></p>
<p>28</p>	<p>RSD Function</p>	<p>The display shows 'RSD' at the top. Below it is a diagram of the inverter system. The 'Enable/Disable' menu is highlighted in red. Navigation buttons at the bottom are labeled 'Return', 'UP', 'Down', and 'Enter'.</p>	<p>This setting allows the user to enable or disable the RSD function of the inverter.</p> <p><b>Range:</b> Enable/Disable <b>Default:</b> Enable</p> <p><b>Enable</b></p> <p><b>Disable</b></p>
<p>29</p>	<p>AFCI Protection</p>	<p>The display shows 'AFCI' at the top. Below it is a diagram of the inverter system. The 'Enable/Disable' menu is highlighted in red. Navigation buttons at the bottom are labeled 'Return', 'UP', 'Down', and 'Enter'.</p>	<p>This setting allows the user to enable or disable the Arc-Fault Circuit Interrupter protection of the inverter.</p> <p><b>Range:</b> Enable/Disable <b>Default:</b> Enable</p> <p><b>Enable</b></p> <p><b>Disable</b></p>



## 12. INVERTER START-UP AND SHUT-DOWN PROCEDURE

### 12.1 START-UP

Follow the steps outlined below to ensure proper start-up and shut-down procedures to avoid potential component damage.

1. Ensure *all* circuit breakers are in the open (OFF) position.
2. Using a multimeter, check the battery bank to ensure no voltage (DC) is present.
3. Check the external PV Isolator Switch via multimeter to ensure the voltage (DC) is in the MPPT's optimal operating range.
4. If utilizing AC output, double check each hot line to neutral coming into inverter to ensure voltage is in operating range of the unit.
5. Upon confirming all voltages are within the inverter's operating range, close (ON) the battery breaker on the front of the unit. Close the external battery breaker between bank and inverter (if equipped).
6. Begin powering batteries on one at a time in  $\approx 5$  second intervals.
7. Close the external PV isolator switch (if equipped). Close PV breaker on the side of the unit.
8. If using AC input, close external breaker between panel and inverter. Next, close the GRID breaker on the front of the unit.
9. Power on the inverter via the power switch on the side of the unit.
10. Close external AC Output breaker (if equipped) going to panel. Turn ON EPS Output (AC Output) switch on side of unit to begin powering loads.

### 12.2 SHUT-DOWN



**Warning:** *Never disconnect battery, PV, or AC input power under loads. If there is an emergency and users must shut down the inverter, please follow the steps outline below.*

1. Turn OFF EPS Output on side of inverter.
2. Open (OFF) GRID/GENERATOR breaker on front of unit.
3. Open LOAD breaker on front of unit. Open external AC output breaker (if equipped).
4. Open external PV isolator switch. Open PV breaker on side of the unit.
5. Open Battery Breaker on front of unit. Open external battery breaker (if equipped).
6. Power down batteries one at a time starting with the master.
7. Turn power switch on side of unit to OFF.



## 13. ERROR/WARNING TABLES

### 13.1 ERROR DEFINITIONS AND TROUBLESHOOTING

Code	Description	Troubleshooting
E000	Internal Communication Fault	Restart inverter. If error persists, contact your distributor
E002	Bat On Mos Fail	Restart inverter. If error persists, contact your distributor
E003	CT Fail	Restart inverter, if the error persists, contact your distributor
E008	CAN communication error in parallel system	Ensure CAN paralleling cables are connected to proper ports between inverters
E009	No master in parallel system	Check parallel setting for Master/Slave to ensure you have only one Master set
E012	UPS output short circuit	Check if the load has a short circuit. If not, turn loads off and reset the system
E013	UPS reserve current	Restart the inverter. If error persists, contact your distributor
E016	Relay fault	Restart inverter. If error persists, contact your distributor
E017	Internal communication fault 2	Restart inverter. If error persists, contact your distributor
E018	Internal communication fault 3	Restart inverter. If error persists, contact your distributor
E019	Bus voltage too high	Check if PV input voltage is >480VDC
E020	EPS connection fault	Check if Inverter and AC connection is installed correctly
E021	PV voltage too high	Check if PV input voltage is >480VDC
E022	Over current internal	Restart inverter. If error persists, contact your distributor
E024	PV short	Check PV connections for short circuit
E025	Temperature too high	The internal temperature of the is too high. Turn the inverter off for 10+ minutes and restart the system. If error persists, please contact your distributor
E026	Internal Fault	Restart inverter. If error persists, contact your distributor
E028	Sync signal lost in parallel system	Ensure CAN paralleling cables are connected to proper ports between inverters
E029	Sync trigger signal lost in parallel system	Ensure CAN paralleling cables are connected to proper ports between inverters
E031	Internal communication fault 4	Restart inverter. If error persists, contact your distributor

## 13.2 WARNING DEFINITIONS AND TROUBLESHOOTING

Code	Description	Troubleshooting
W000	Battery communication failure	Check your battery settings to ensure they are set for your specific battery type. Check your battery communications cable for proper pinning/installation.
W001	AFCI Com failure	Restart Inverter. If the error persists, contact your distributor
W002	AFCI High	Check each PV string for correct open circuit voltage and short circuit current. If the PV strings are in good condition, please clear the fault on inverter LCD
W003	Meter communication failure	Check communications cable. Contact your distributor if error persists
W004	Battery BMS fault	Inverter is receiving incorrect information from battery's BMS. Restart batteries and ensure your communication cables installed correctly. If error persists, please contact your distributor
W006	RSD Active	Check if the RSD switch is pressed
W008	Firmware mismatch	Contact your distributor/installer for Firmware update
W009	Fan Stuck	Check if the fan is operable
W012	Bat on Mos	Restart the inverter. If error persists, please contact your distributor
W013	Over temperature	The temperature of inverter is nearing the high limit
W015	BatReverse	Double check battery connections to inverter. If error persists, contact your distributor
W018	AC Frequency out of range	Check AC frequency to ensure it is in the operable range
W019	AC inconsistent in parallel system	Ensure the AC input is from a common source and installed to each inverter in parallel. If error persists, contact your distributor
W020	PV Isolation low	Restart inverter. If the error still persists, contact your distributor
W025	Battery voltage high	Battery voltage is nearing the high limit
W026	Battery voltage low	Battery voltage is nearing the low limit
W027	Battery open	Check your battery for voltage via multimeter. Ensure all wires are correctly installed to inverter and battery
W028	Inverter overload	Inverter is running beyond max. output
W029	Inverter voltage high	Restart the inverter. If error persists, contact your distributor
W031	Inverter VDC high	Restart the inverter. If error persists, contact your distributor

## 14. INVERTER MAINTENANCE

Electrical equipment must be properly maintained to increase longevity and consistency. Follow the steps below to help prevent component damage/deterioration.

1. Inspect the inverter every month to confirm nothing covers the inverters heatsink. If there is, shut down the inverter and clear the heat sink to restore proper cooling.
2. Inspect the inverter every 3 months to verify the operating parameters are normal, and there is no abnormal heating or noise from all components in the system.
3. Inspect the inverter every 6 months to check for any damaged cables, accessories, or terminals, and inspect the inverter itself.

## 15. TECHNICAL SPECIFICATIONS

<b>AC INPUT DATA</b>	
NOMINAL AC VOLTAGE	120-240VAC
FREQUENCY	50/60Hz
MAX. CONTINUOUS AC CURRENT	37.5A @ 240VAC
MAX. AC INPUT POWER	9000W
<b>AC GRID OUTPUT DATA</b>	
MAX. CONTINUOUS OUTPUT CURRENT @ 240V	25A
AC BYPASS (GRID)	50A
OUTPUT VOLTAGE	120/240VAC
NOMINAL POWER OUTPUT	6000W
OUTPUT FREQUENCY	50/60Hz
POWER FACTOR	0.99 @ full load
REACTIVE POWER ADJUST RANGE	(-0.8) – (+0.8) leading adjustable
<b>BACKUP/UPS AC OUTPUT DATA</b>	
RATED OUTPUT CURRENT @ 240V	25A
AC BYPASS (GENERATOR)	30A
RATED OUTPUT POWER	6000W
MAX CONT. LINE WATTAGE	3000W
SURGE CAPACITY	12kW for ≈3.5 seconds   11kW for ≈5 seconds
OPERATING FREQUENCY	50/60Hz
THD (V)	<3%
SWITCHING TIME	<15ms @ Single / <30ms @ Parallel
<b>PV INPUT DATA</b>	
NUMBER OF MPPTS	2
INPUTS PER MPPT	1
MAX. USABLE INPUT CURRENT	17/17A
MAX. SHORT CIRCUIT INPUT CURRENT	25/25A
DC INPUT VOLTAGE RANGE	100-480 VDC
UNIT STARTUP VOLTAGE	100 VDC ± 10 VDC
MPP OPERATING VOLTAGE RANGE	120-385 VDC
NOMINAL MPPT VOLTAGE	320 VDC

MAXIMUM UTILIZED SOLAR POWER	8000W (4000W per MPPT)		
RECOMMENDED MAXIMUM SOLAR INPUT	10,000W		
<b>EFFICIENCY</b>			
MPPT EFFICIENCY	99%		
BATTERY CHARGING EFFICIENCY	93%		
BATTERY DISCHARGING EFFICIENCY	93%		
IDLE CONSUMPTION (STANDBY MODE) *	w/ PV <30W	w/ Battery ≈50W	w/ AC <50W
<b>BATTERY DATA</b>			
TYPE	Lead-acid/Lithium		
MAX. DISCHARGE CURRENT	140A		
MAX. CHARGE CURRENT	125A **		
NOMINAL VOLTAGE	48 VDC		
BATTERY VOLTAGE RANGE	46.4-60 VDC (Lithium); 38.4-60 VDC (Lead-Acid)		
REC. BATTERY CAPACITY PER INVERTER	>200Ah		
HIGH DC CUT-OFF VOLTAGE	59VDC (Lithium)   60VDC (Lead-acid)		
HIGH DC RECOVERY VOLTAGE	57.4VDC(Li)   58VDC(Lead-Acid)		
	57.4VDC (Lithium)		
LOW DC WARNING VOLTAGE	LOAD<20%	44.0 VDC (Configurable)	
	20%≤LOAD<50%	Warning Voltage @Load <20% - 1.2V	
	LOAD≥50%	Warning Voltage @Load <20% - 3.6V	
LOW DC WARNING VOLTAGE RETURN	Low DC Warning Voltage @Different Load +2V		
LOW DC CUT-OFF VOLTAGE	LOAD<20%	42.0VDC (Configurable)	
	20%≤LOAD<50%	Cut-Off Voltage @Load <20% - 1.2V	
	LOAD≥50%	Cut-Off Voltage @load <20% - 3.6V	
LOW DC CUT-OFF RETURN VOLTAGE	CUT-OFF VOLTAGE @LOAD <20% ≥45V	Low DC Cut-Off Voltage @load <20% +3V	
	CUT-OFF VOLTAGE @LOAD <20% <45V	48V	
LOW DC WARNING SOC	20% SOC (Configurable)		
LOW DC WARNING RETURN SOC	Low DC Warning SOC +10%		
LOW DC CUT-OFF SOC	15% SOC (Grid ON) (Configurable)		
	15% SOC (Grid OFF) (Configurable)		
LOW DC CUT-OFF RETURN SOC	Low DC Cut-Off SOC +10%		
CHARGE CUT-OFF VOLTAGE	58.4VDC		
<b>GENERAL DATA</b>			
MAX. UNITS IN PARALLEL	16		
INTEGRATED DISCONNECT	Yes		
DC SWITCH RATING FOR EACH MPPT	Yes		
DIMENSIONS	18×25.5×5.25 in (457×648×132mm)		
WEIGHT	52.9 lbs. (24kg)		

COOLING CONCEPT	Fan
TOPOLOGY	TL (Transformerless)
RELATIVE HUMIDITY	5-95%
ALTITUDE	<6561ft
OPERATING TEMPERATURE RANGE	32 – 113°F (0 – 45°C)
STORAGE TEMPERATURE RANGE	5 – 140°F (-15 – 60°C)
NOISE EMISSION (TYPICAL)	<58 dB
DISPLAY	LCD + LED
COMMUNICATION INTERFACE	RS485/Wi-Fi/CAN
STANDARD WARRANTY	5-year standard warranty ***
PV REVERSE POLARITY PROTECTION, POLE SENSITIVE LEAKAGE CURRENT MONITORING UNIT, SURGE PROTECTION DEVICE, OUTPUT OVER- VOLTAGE PROTECTION, OUTPUT OVER- VOLTAGE PROTECTION VARISTOR	Yes

## STANDARDS AND CERTIFICATIONS

UL1741

FCC PART 15, CLASS B

## INGRESS PROTECTION RATING

IP20

*\*\*Idle consumption value tested with constant 300VDC PV source*

*\*\*115A @ 48VDC (AC), 125A @48VDC (PV)*

*\*\*\*See EG4® Warranty Registration for terms and conditions*







## CONTACT US

EMAIL: [support@eg4electronics.com](mailto:support@eg4electronics.com)

PHONE: +1 (903) 609-1988

WEBSITE: [www.eg4electronics.com](http://www.eg4electronics.com)